

**SINGER**  
147-120

# USE ONLY **SINGER**\* OILS and LUBRICANTS

*They insure freedom from lubricating trouble and give longer life to sewing equipment*

*The following are the correct lubricants for this machine:*

**TYPE B** — MANUFACTURING MACHINE OIL, HEAVY GRADE

*When a stainless oil is desired, use:*

**TYPE D** — MANUFACTURING MACHINE OIL, STAINLESS, HEAVY GRADE

## OTHER **SINGER** LUBRICANTS

**TYPE E** — THREAD LUBRICANT

For lubricating the needle thread of sewing machines for stitching fabrics or leather where a thread lubricant is required.

**TYPE F** — MOTOR OIL

For oil lubricated motors and plain bearings in power tables and transmitters.

**NOTE:** All of the above oils are available in 1 quart, 1 gallon and 5 gallon cans or in 55 gallon drums.

**GEAR LUBRICANT**

This specially prepared grease is recommended for gear lubrication on manufacturing sewing machines.

**BALL BEARING LUBRICANT**

This pure grease is specially designed for the lubrication of ball bearings and ball thrust bearings of motors and electric transmitters, ball bearing hangers of power tables, etc. **Furnished in 1 lb. and 4 lb. tins.**

20534

## INSTRUCTIONS FOR USING **SINGER**\* SEWING MACHINE **147-120**

PULLER FEED

TWO NEEDLES TWO LOOPERS  
AUTOMATIC OILING SYSTEM

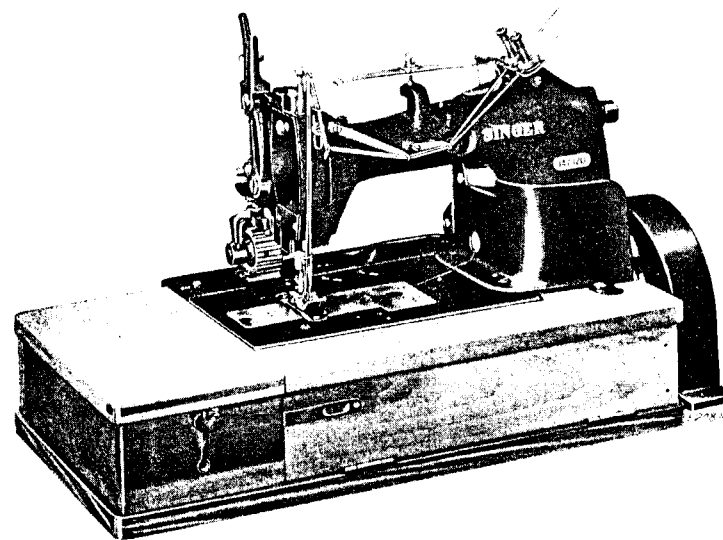

**CAUTION:**—Special attention is called to the lubricating instructions on pages 4 to 7

\*A TRADE MARK OF

**THE SINGER MANUFACTURING COMPANY**

## TO ALL WHOM IT MAY CONCERN:

The improper placing or renewal of the Trade Mark "**SINGER**" or any other of the Trade Marks of The Singer Manufacturing Company (all of which are duly Registered Trade Marks) on any machine that has been repaired, rebuilt, reconditioned, or altered in any way whatsoever outside a **SINGER** factory or an authorized **SINGER** agency is forbidden.

### THE IMPORTANCE OF USING **SINGER**\* PARTS AND NEEDLES IN **SINGER** MACHINES

The successful operation of **SINGER** machines can only be assured if **SINGER** parts and needles are used. Supplies are available at all **SINGER** Shops for the Manufacturing Trade, and mail orders will receive prompt attention.

**SINGER** Needles should be used  
in **SINGER** Machines  
These Needles and their Containers  
are marked with the  
Company's Trade Mark "SIMANCO.\*" 1

Needles in Containers marked  
"FOR **SINGER** MACHINES"  
are NOT **SINGER** made needles. 2

Copyright, U. S. A., 1950 and 1952  
by The Singer Manufacturing Company  
All Rights Reserved for All Countries

## DESCRIPTION

**Machine 147-120** is a high speed, two needle, two looper, two-thread chain stitch machine, designed for stitching a wide variety of work in light and medium weight fabrics.

It has a **puller feed**, equipped with upper and under feed rolls to assist in carrying the stitched material away from the needles. Puller feed rolls can be furnished with coarse or fine teeth or with a smooth roller face, according to the requirements of the material to be stitched. The under feed roll is independently adjustable to synchronize the puller feed motion with the motion of the drop feed. See page 12.

Needle gauges are from 3/32 to 1/2 inch in steps of 1/32 inch. machine orders must specify gauge required.

The machine is adjustable to produce from 5 to 25 stitches to the inch.

Needle bar stroke is 1-7/32 inches.

Work space at right of needles is 8-1/4 inches.

The loopers may be thrown out of position for convenience in threading. See Fig. 16, page 10.

The machine has an automatic oiling system with a central reservoir from which, by splash and through tubing, all principal bearings are lubricated. See Fig. 10, page 7.

The arm rotary shaft is counterbalanced. It is equipped with ball bearings for the intermediate and rear bearings adjacent to the machine pulley.

Machine pulley **131914**, 3/8 inch V-belt, is regularly furnished with the machine.

The machine is regularly equipped with a foot lifter. A knee lifter will be furnished, instead of a foot lifter, when specified on order.

Machine base is 16-1/2 inches long.

When in operation, the top of the machine pulley must always turn over away from the operator.

## TO SET UP THE MACHINE

Before placing the machine on its iron base, see that the rubber insulating bushings are in place in the four holes in the machine bed, and that the four felt pads are over the studs in the corners of the base. Place the machine on these pads, with the four studs through the rubber bushings.

**CAUTION:**—After setting up, do not start the machine until it has been thoroughly oiled, as instructed on pages 4 to 7.

## TO OIL THE MACHINE

Use "TYPE B" or "TYPE D" OIL, sold only by Singer Sewing Machine Company. For description of these oils, see inside front cover.

**Automatic Oiling System:**—An agitator on the lower end of the connecting rod contacts the oil in the central reservoir, at each revolution of the main shaft, lubricating various bearings **inside** the arm by splash. Pipes and wicks distribute oil to the principal bearings **outside** the arm. See large diagrams, **Fig. 10, page 7**, showing distribution of oil.

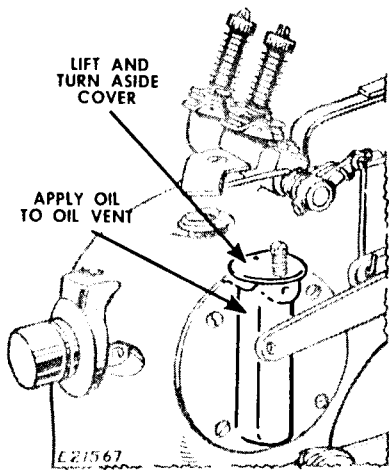

Fig. 2  
Oil Vent for Central Reservoir

To insure operation of this system and to avoid serious damage to the machine, the following instructions should be carefully observed.

A new machine, or one that has been idle for some time, must be oiled, as described below and on pages 5 to 7.

**CAUTION:**—The cover over the oil vent in Fig. 2, must be kept closed at all times, except when oiling.

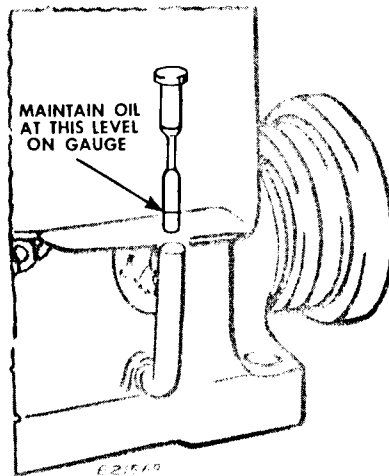

Fig. 3  
Oil Gauge

Never permit oil level to drop more than 1/4 inch below level indicated in Fig. 3, on gauge, when the machine is at rest.

Before further oiling, remove the right hand slide plate and the face plate. The work plate, throat plate and other parts of the machine are removed in Figs. 4, 6 and 7 for the purpose of illustration only.

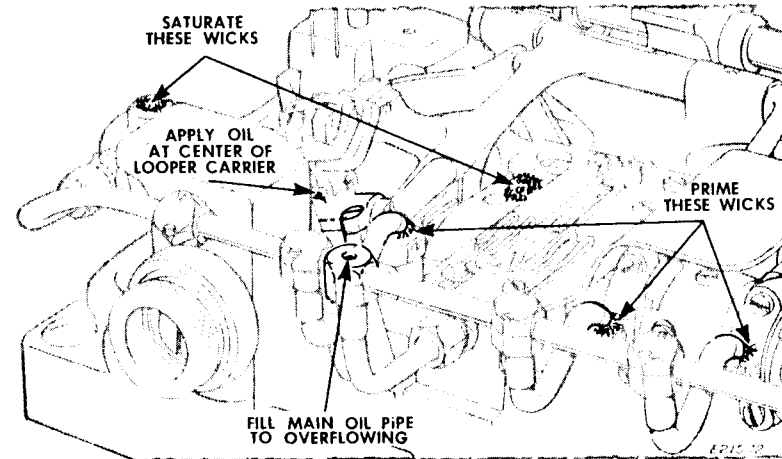

Fig. 4. Main Oil Pipe

The main oil pipe should be filled to **overflowing**, to aid in priming the various oil wicks.

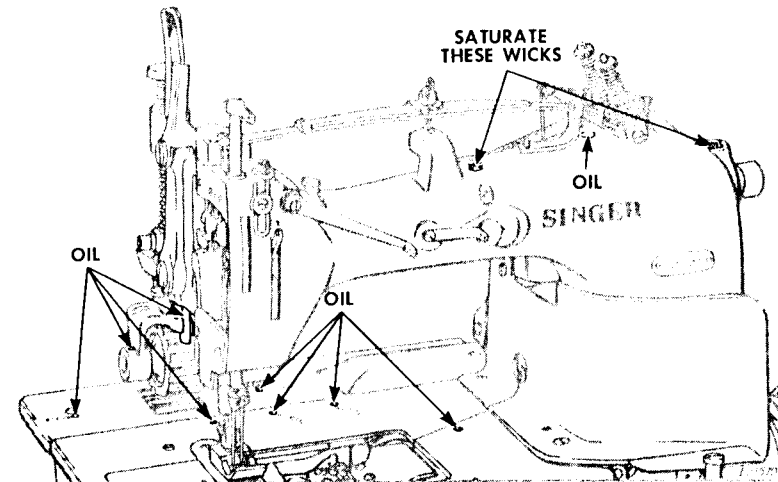

Fig. 5. Oiling Points in Front and on Top of Machine

**IMPORTANT:**—After oil has been applied to all wicks, oil holes and places where parts are in movable contact, as instructed in Figs. 2 to 10, run the machine at moderate speed for five minutes. Stop the machine. Let it stand idle for a few minutes. Check oil level in reservoir. If necessary, add sufficient oil to bring it to level indicated in Fig. 3, on gauge.

Fill puller feed clutch shaft with oil, as instructed in Fig. 7. Do not use kerosene at any time. Securely tighten thumb screw after oil has been applied.

**NOTE:**—The letter "o" marked on the front and rear couplings, see Fig. 8, must always be at the top, to insure that the oil spoon, attached to the inner end of each coupling, is open-side up to receive oil.

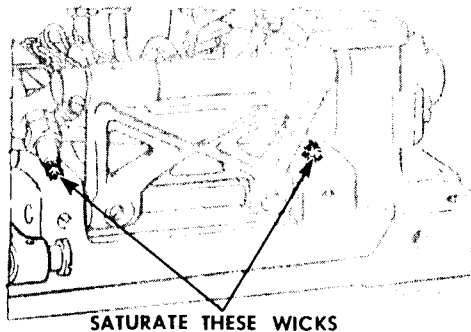

Fig. 6. Wicks for Feed Rocking Frame

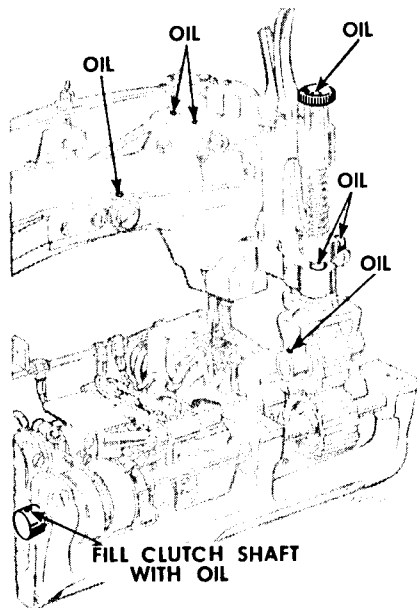

Fig. 7  
Oiling Points in Rear and on Top of Machine

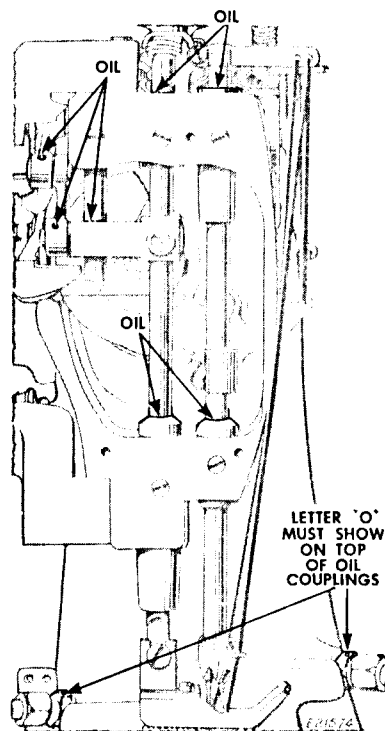

Fig. 8  
Position of Oil Couplings

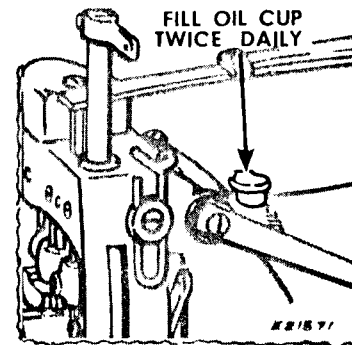

Fig. 9. Oil Cup

A machine in daily use must be oiled twice each day, in the following manner:

1. Apply oil to all oil holes marked "OIL."
2. Fill oil cup illustrated in Fig. 9.
3. Check oil level in reservoir and add oil through oil vent, when necessary, as instructed in Figs. 2 and 3, page 4.

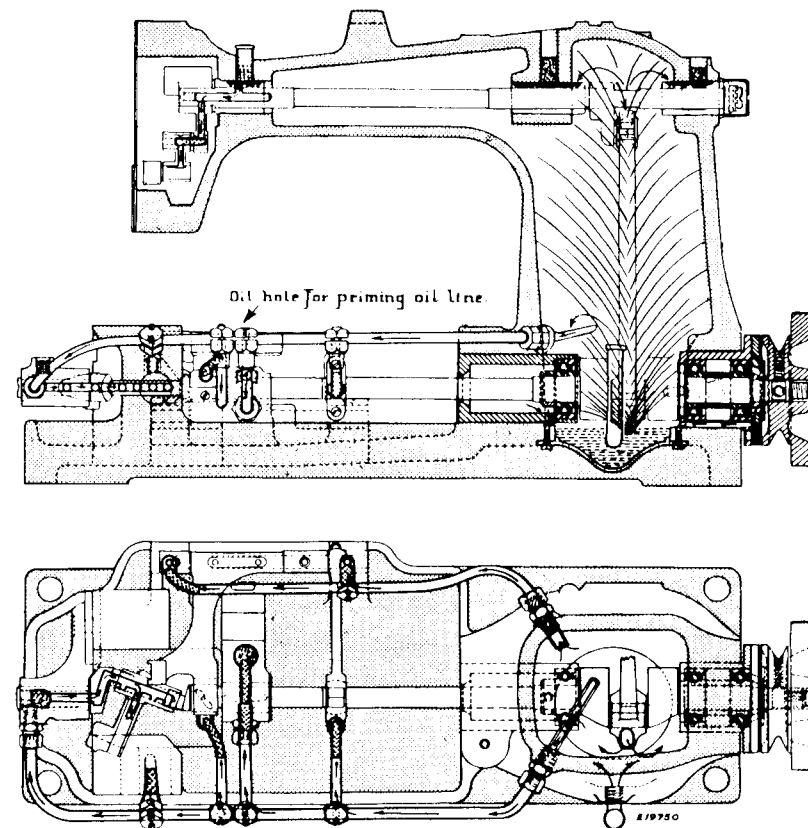

Fig. 10. Diagrams Showing Wicks and Bearings Oiled by Automatic Splash, also Bearings Oiled by Gravity Through Tubes on Outside of Machine

## NEEDLES

Needles for Machine 147-120 are of **Class** and **Variety** 62 x 43 in **Sizes** 9, 10, 11, 12, 13, 14, 16, 17, 18, 19, 20, 21, 22, 23 and 24.

The size of the needle to be used is determined by the size of the thread which must pass freely through the needle eye. Rough or uneven thread, or thread which passes with difficulty through the needle eye, will interfere with the proper formation of the stitch.

Orders for needles must specify the **Quantity** required, the **Size** number; also the **Class** and **Variety** numbers separated by the letter "x."

The following is an example of an intelligible order:

"100 No. 17, 62 x 43 Needles"

Best stitching results will be obtained with the needles sold by Singer Sewing Machine Company.

### TO SET THE NEEDLES

(See Fig. 11)

Turn machine pulley over away from the operator until needle bar moves up to its highest point. Loosen set screws **A**. Fig. 11.

Insert needles up into needle clamp as far as they will go, as shown in Fig. 11, with **single continuous groove toward the operator**. Then securely tighten the two needle set screws **A**.

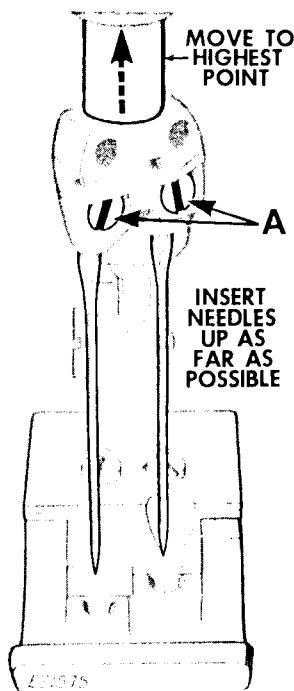

Fig. 11. Setting the Needles

### TO THREAD THE NEEDLES

Turn machine pulley over away from operator until **needle bar** is at its **highest** position.

Pass each thread from unwinder through threading points, in the order shown in Figs. 12 to 14.

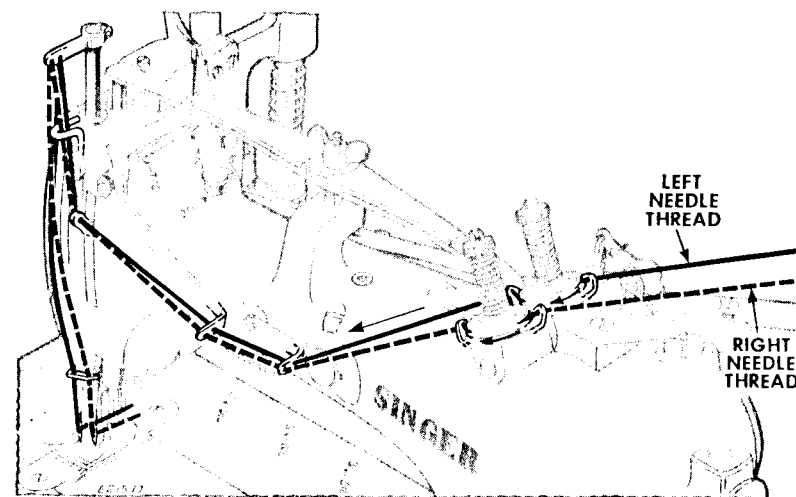

Fig. 12. Upper Threading

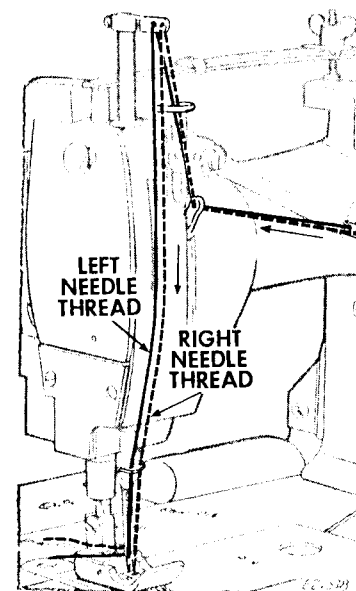

Fig. 13  
Threading Needle Thread Take-up

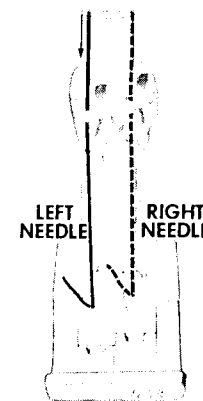

Fig. 14  
Threading the Needles

**Dotted line** indicates thread for **right hand** needle.

Draw about two inches of thread through the eye of each needle, with which to commence sewing.

## TO THREAD THE LOOPERS

Remove the bed side plate from the machine bed.

Turn the machine pulley over away from operator until the **loopers** are at the end of their backward stroke (**extreme right-hand position**).

Turn looper throw-out knob counterclockwise, as far as it will go, bringing loopers into convenient position for threading and then pass each thread from unwinder through threading points in the order shown in **Figs. 15 to 17**.

**Dotted line** indicates thread for rear looper.

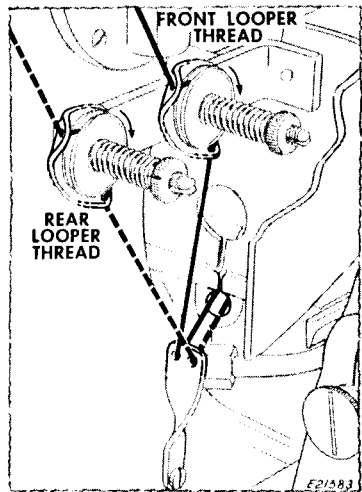

Fig. 15. Threading Looper Tension Discs

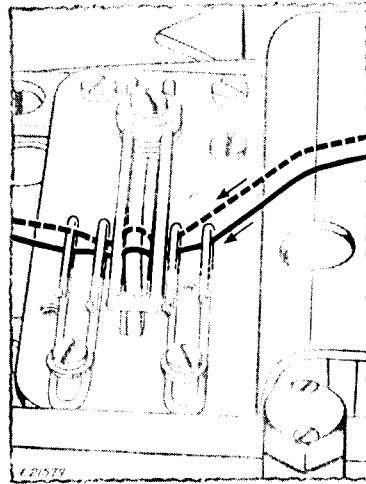

Fig. 16. Threading Looper Take-up

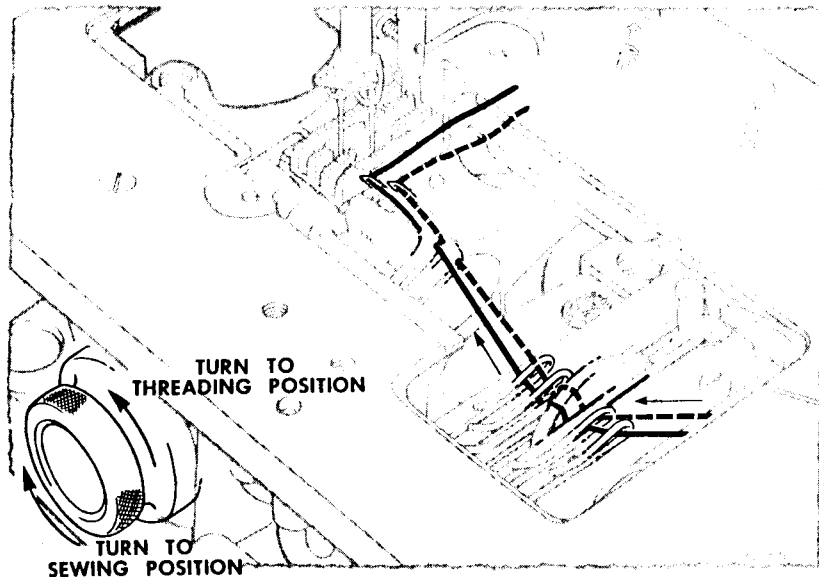

Fig. 17. Threading the Loopers

Draw about two inches of thread through eye of each looper, with which to commence sewing.

Turn throw-out knob clockwise, as far as it will go, to bring loopers into sewing position.

## TO REGULATE THE TENSIONS

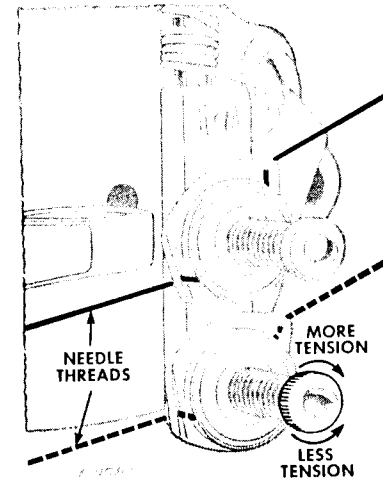

Fig. 18. Regulating Tension on Needle Threads  
(View on Top of Machine)

Tension on the **needle threads** should be just enough to **set the stitch** properly in the material.

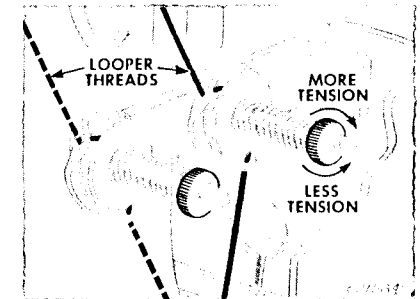

Fig. 19. Regulating Tension on Looper Threads

For average sewing, the tension on the **looper threads** should be very light.

## TO REGULATE THE PRESSURE ON THE MATERIAL

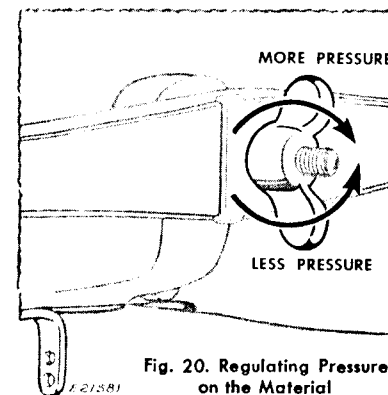

Fig. 20. Regulating Pressure on the Material  
(View on Top of Machine)

Turn wing nut, shown in **Fig. 20**, to right or left, as required.

Always use the **lightest** pressure possible to permit higher working speeds.

### TO REGULATE THE LENGTH OF STITCH

Loosen the two set screws and turn the regulating screw, in **each** eccentric, as instructed in **Fig. 21**, below.

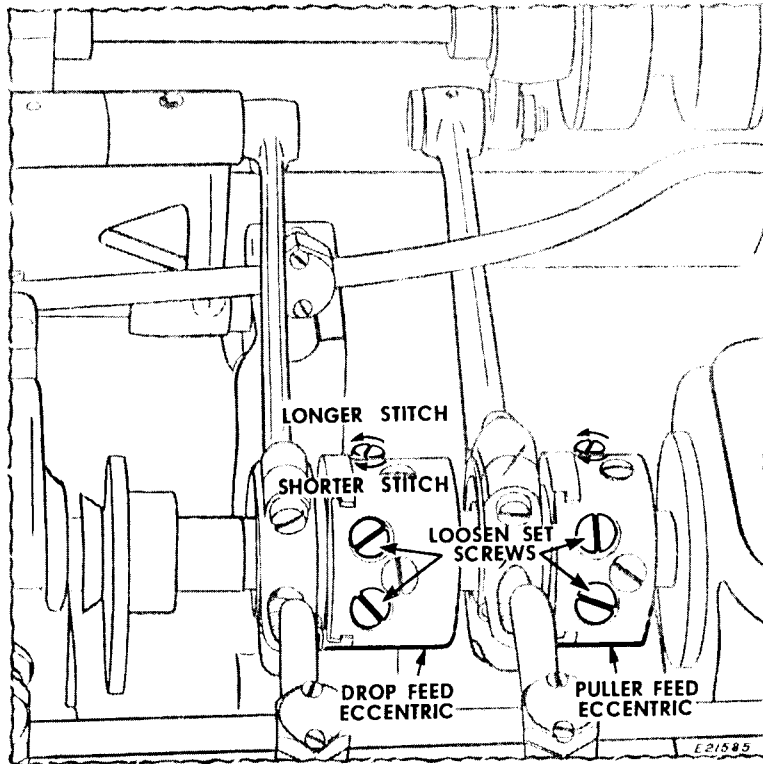

Fig. 21. Regulating the Length of Stitch

**NOTE:**—Set the puller feed for a **slightly longer stitch** than the drop feed, to insure that the puller feed will be in motion during the **entire movement** of the drop feed.

**SINGER** Needles should be used  
in **SINGER** Machines  
These Needles and their Containers  
are marked with the  
Company's Trade Mark "SIMANCO.\*" 1

Needles in Containers marked  
"FOR SINGER MACHINES"  
are **NOT SINGER** made needles. 2