

Form 20484
(152)
Printed in U.S.A.

**LIST
OF
PARTS**

**MACHINES
Nos. 114-50 to 114-54**

**** A TRADE MARK OF
THE SINGER COMPANY**

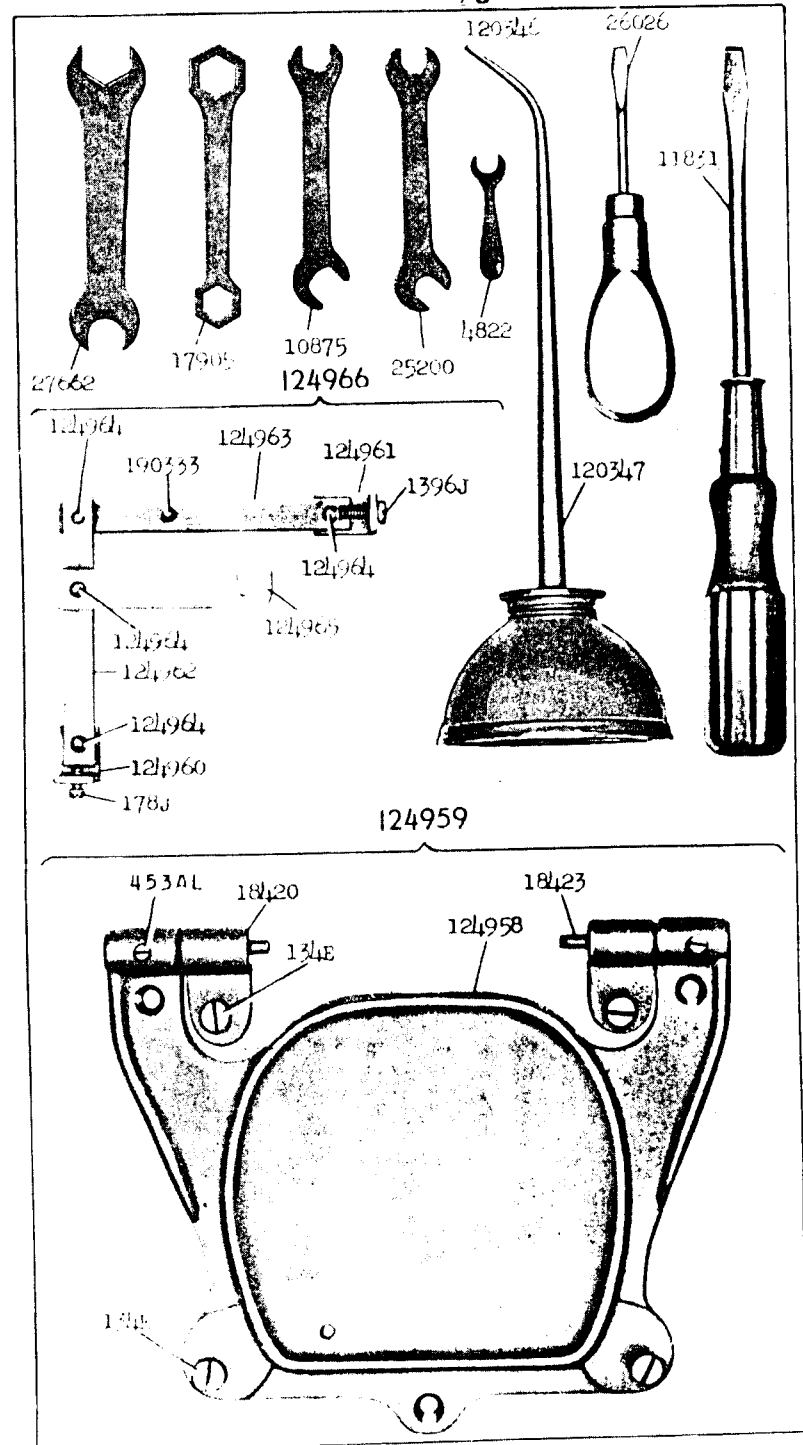

23174 - 1/2

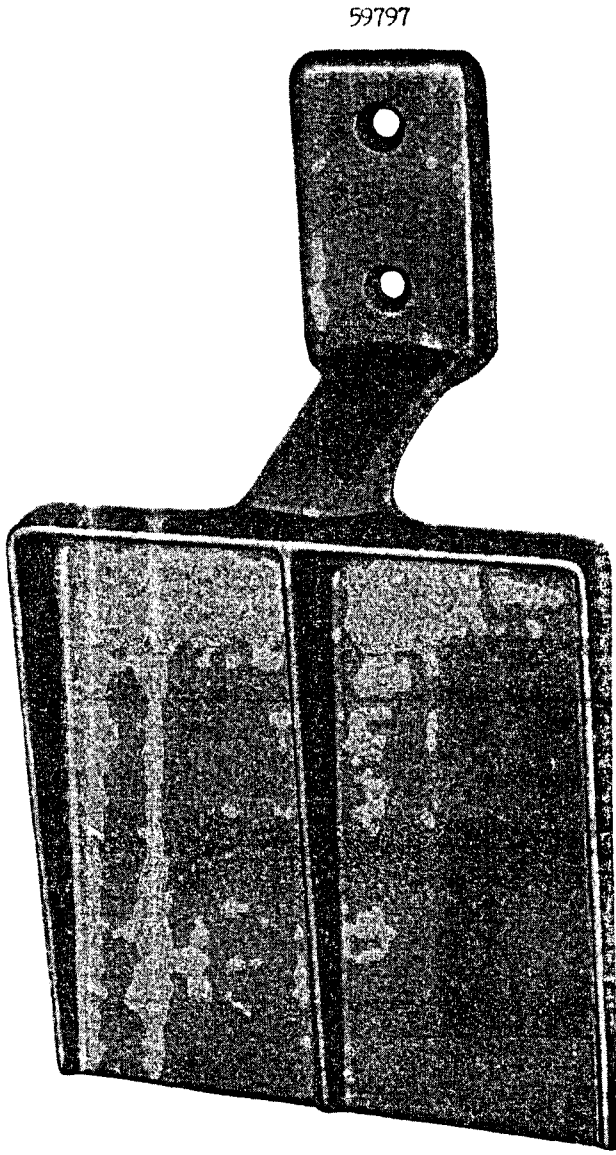

23195 - 2/3

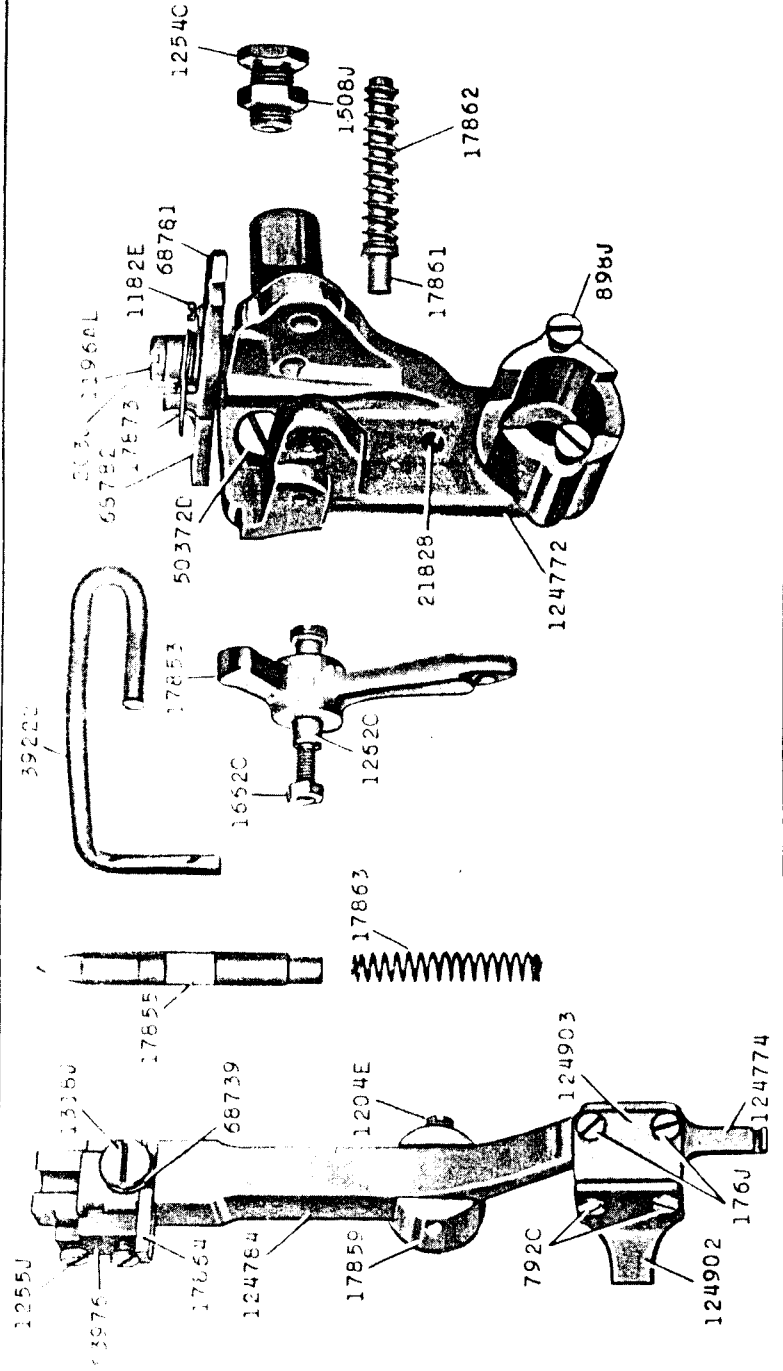

23196 - 2/3

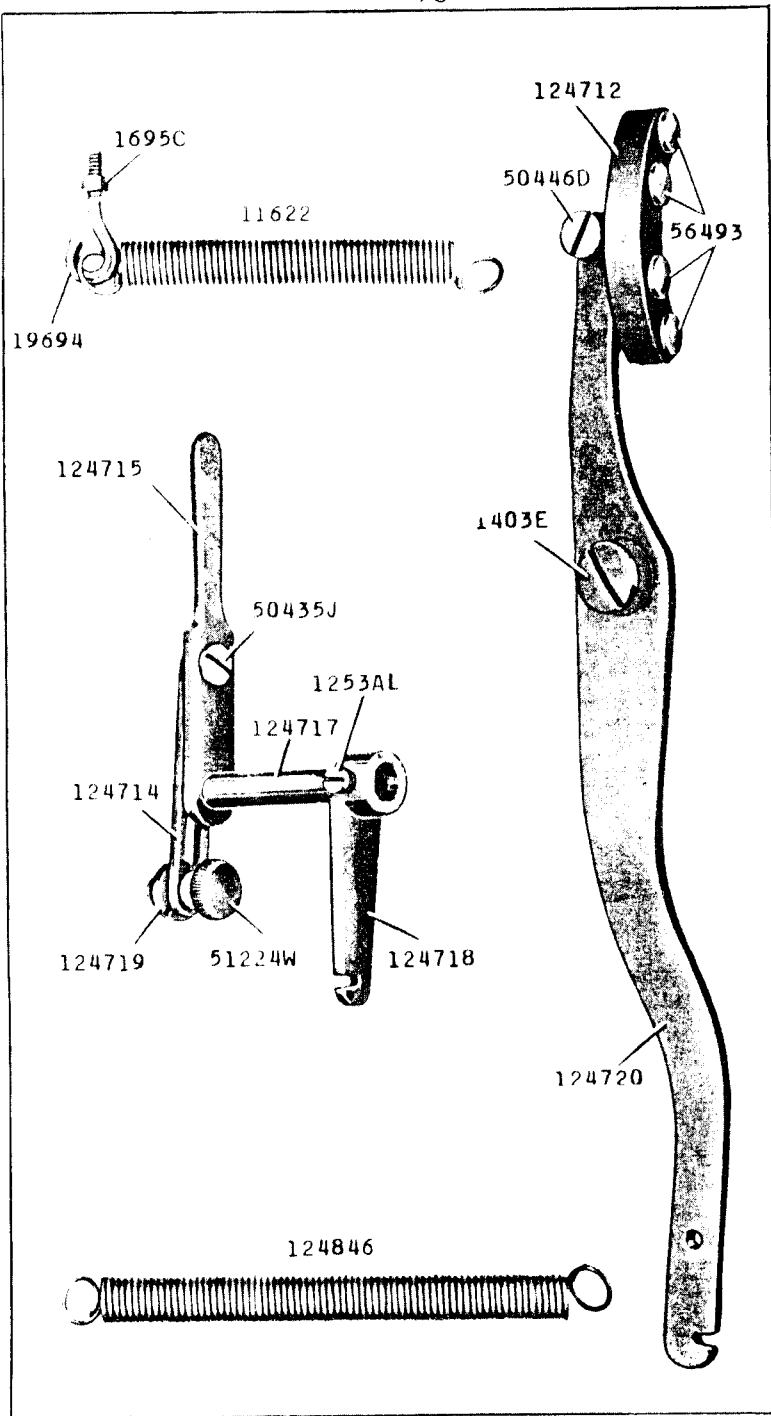

23197 - 1/2

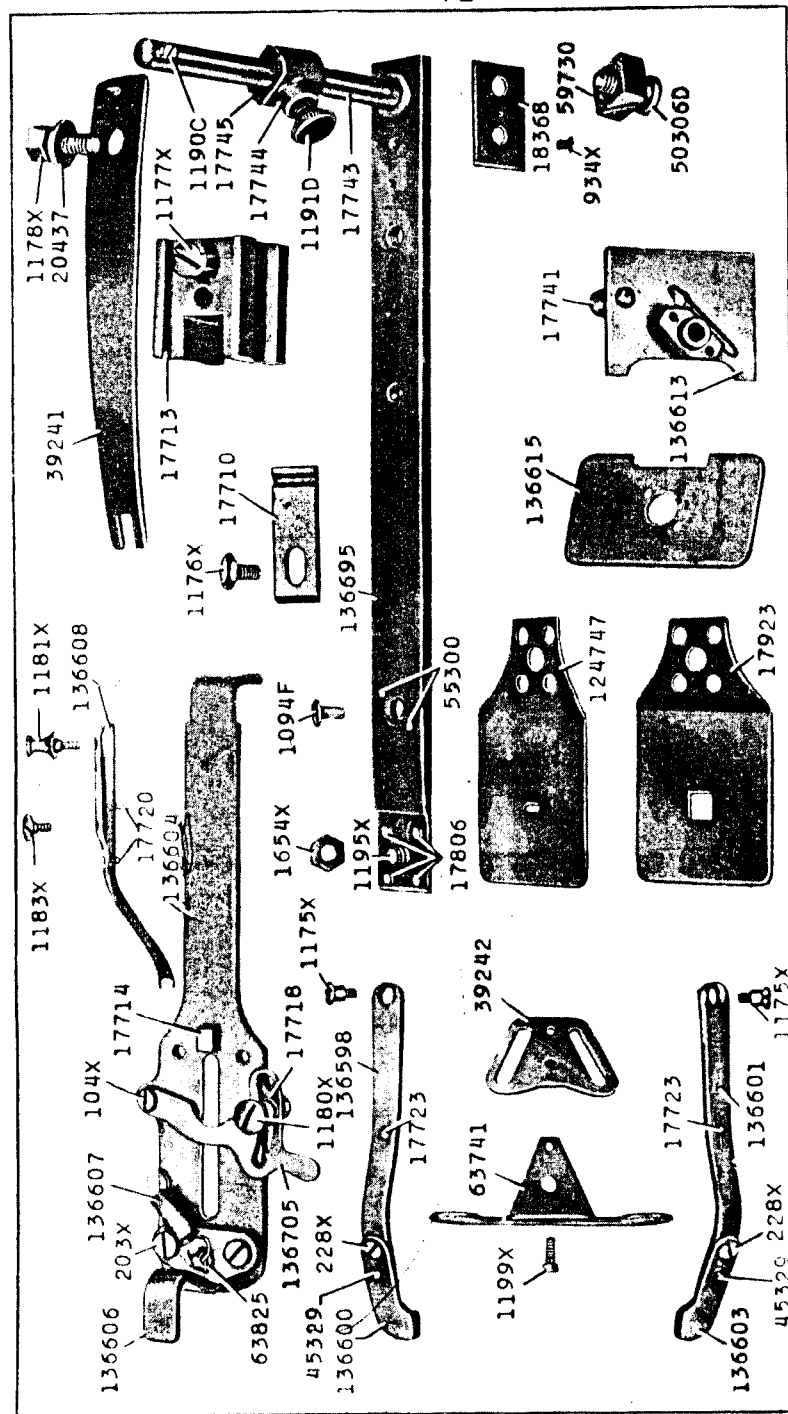

25261-1/3

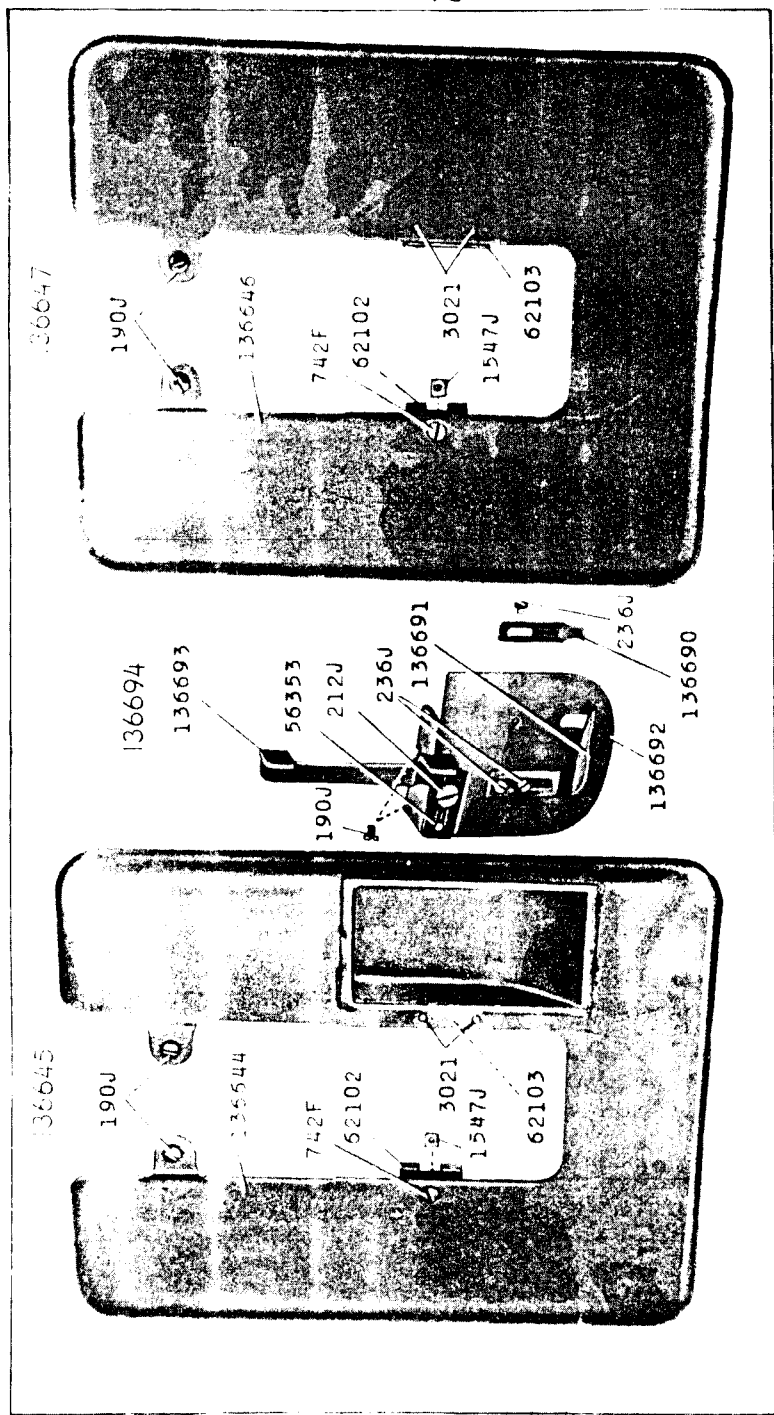

25262-1/2

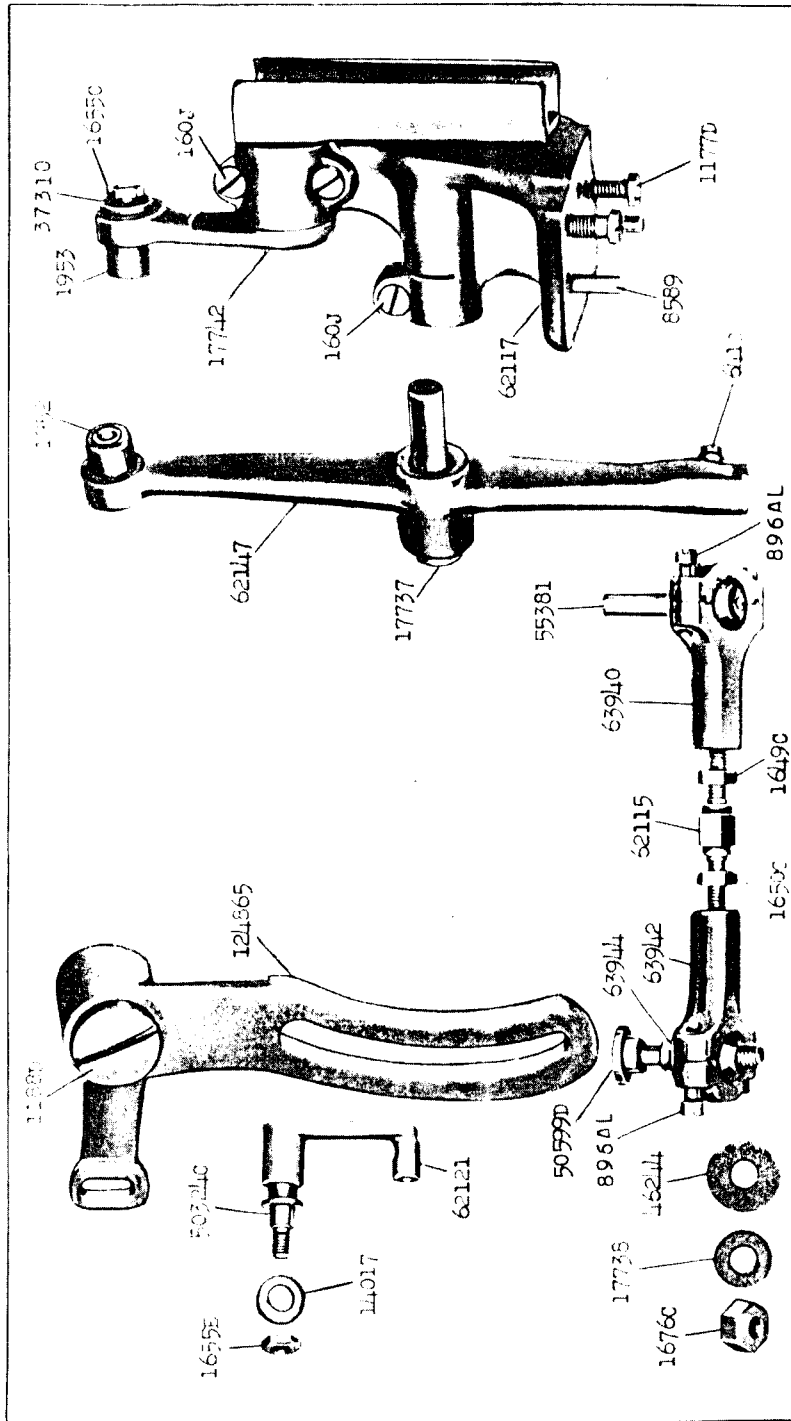

25265 - 1/4

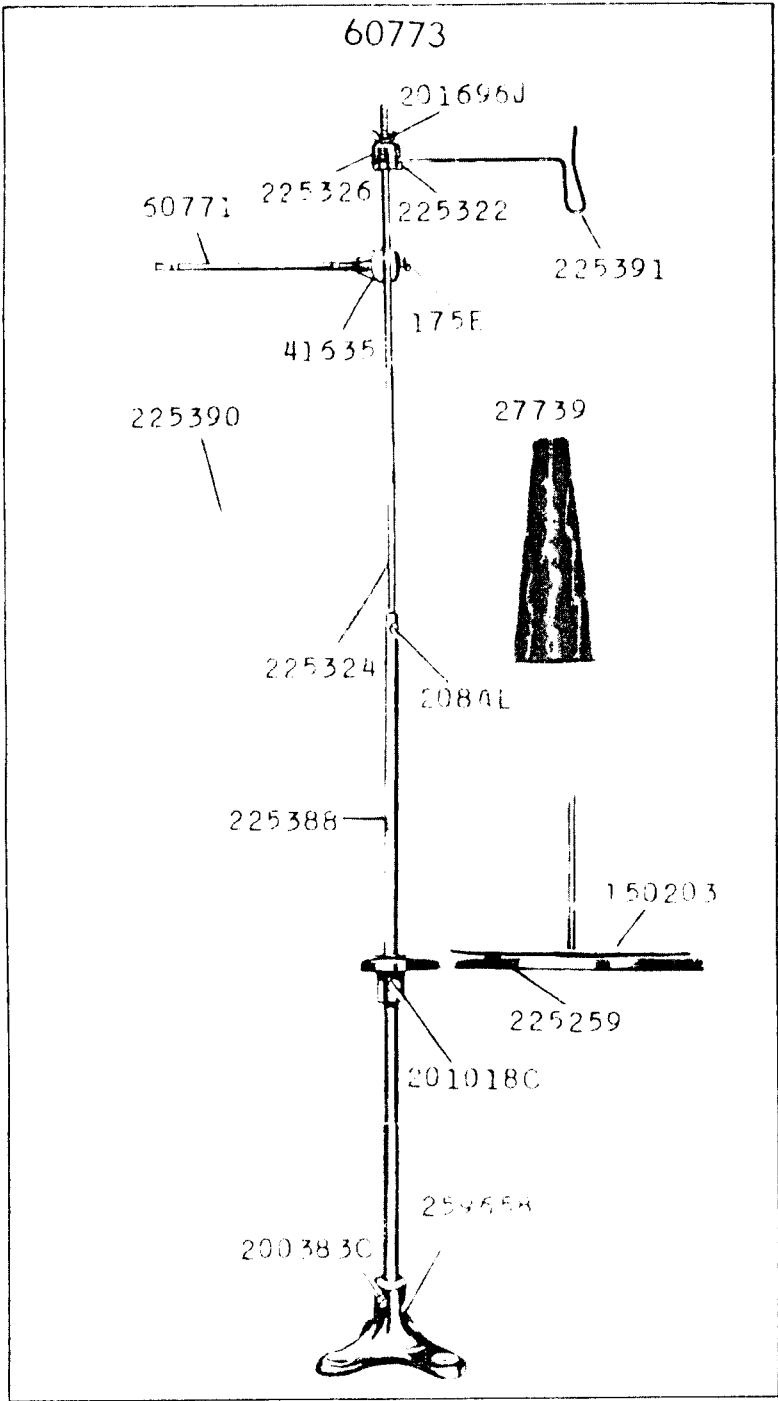

25266-1/4

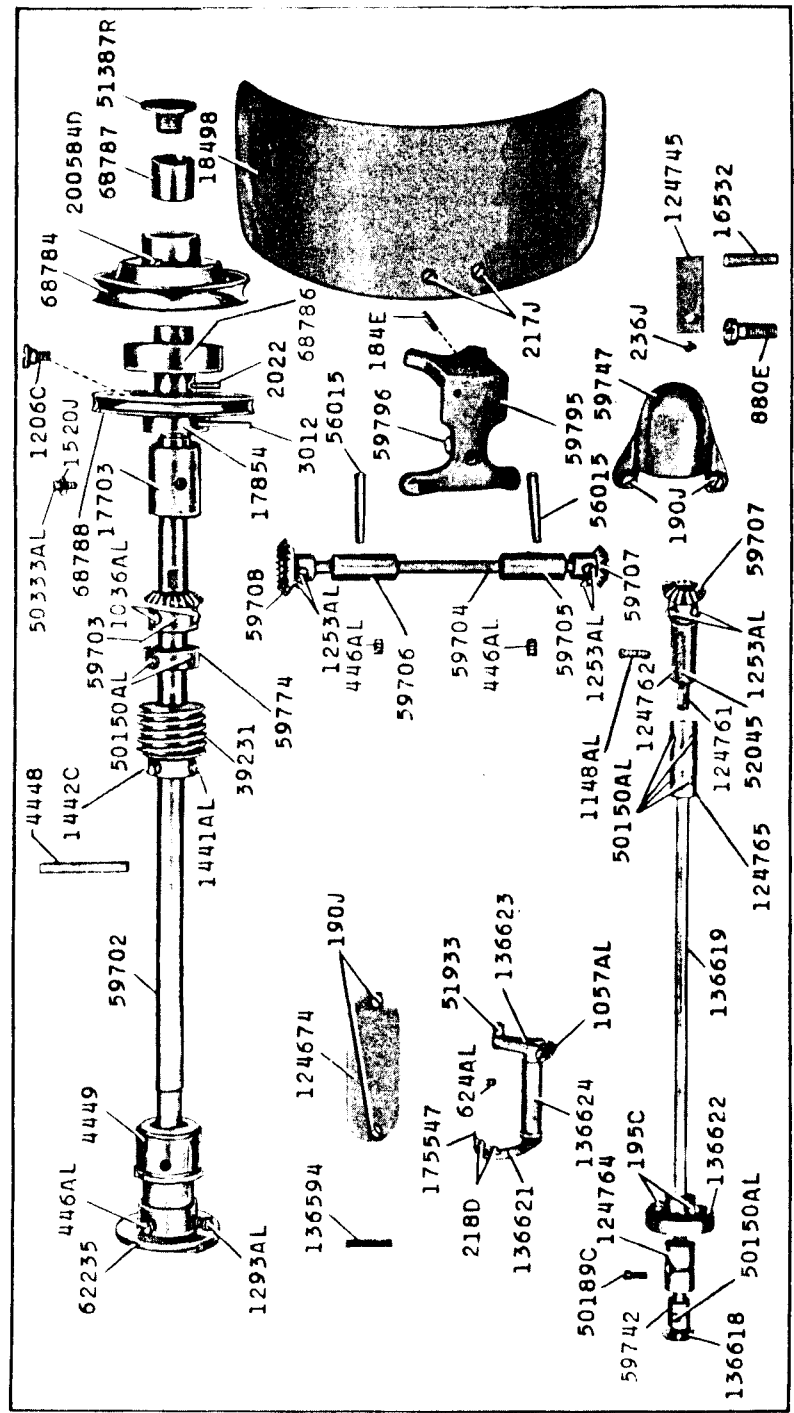

25267-1/4

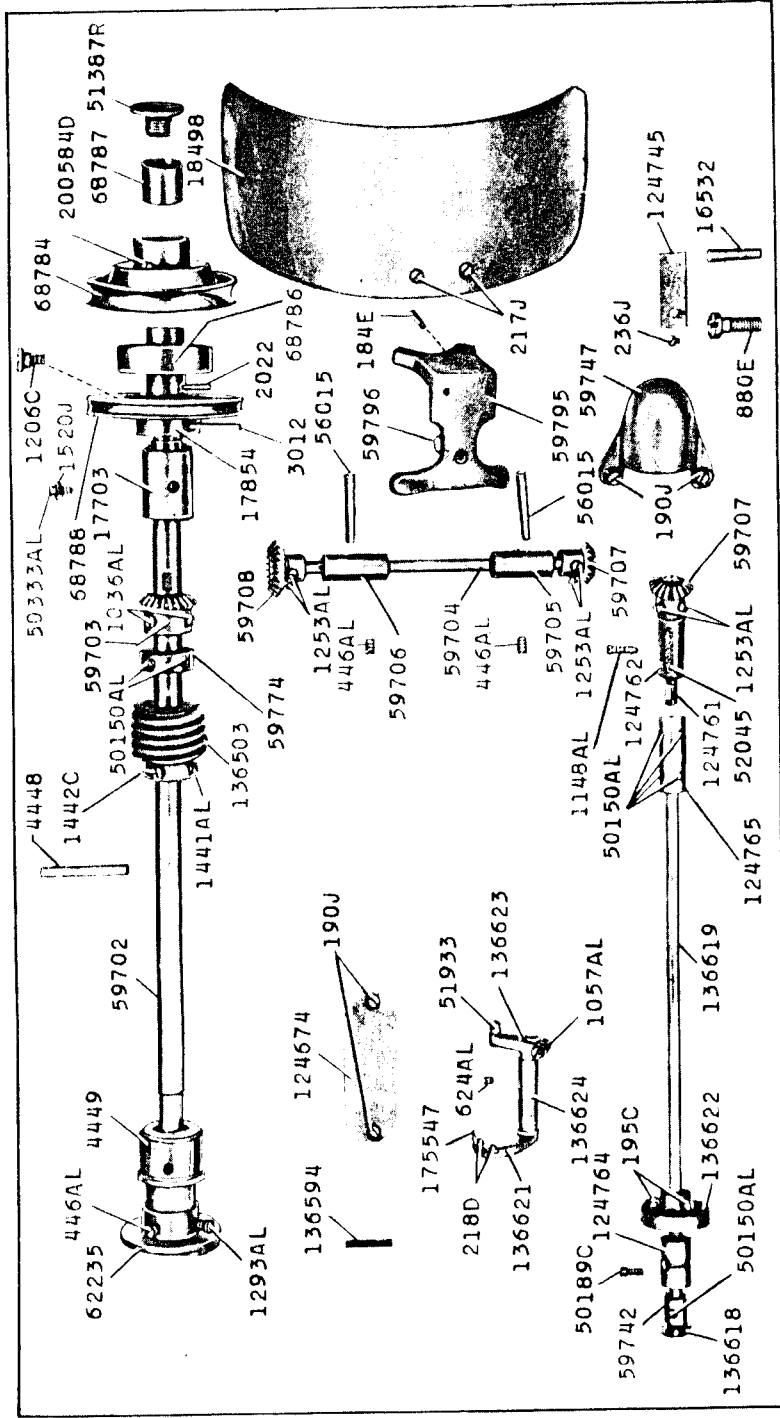

25268-1/4

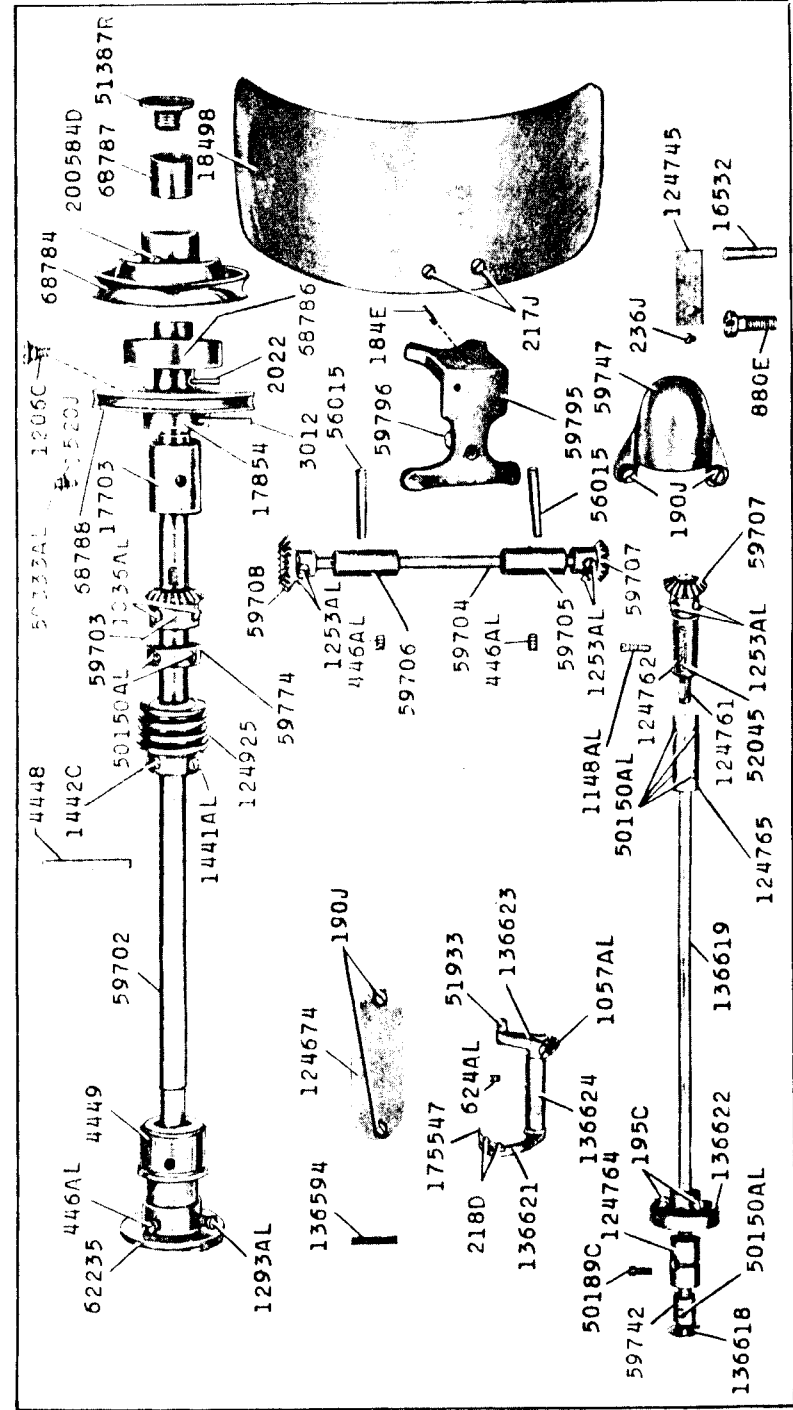

25269-1/2

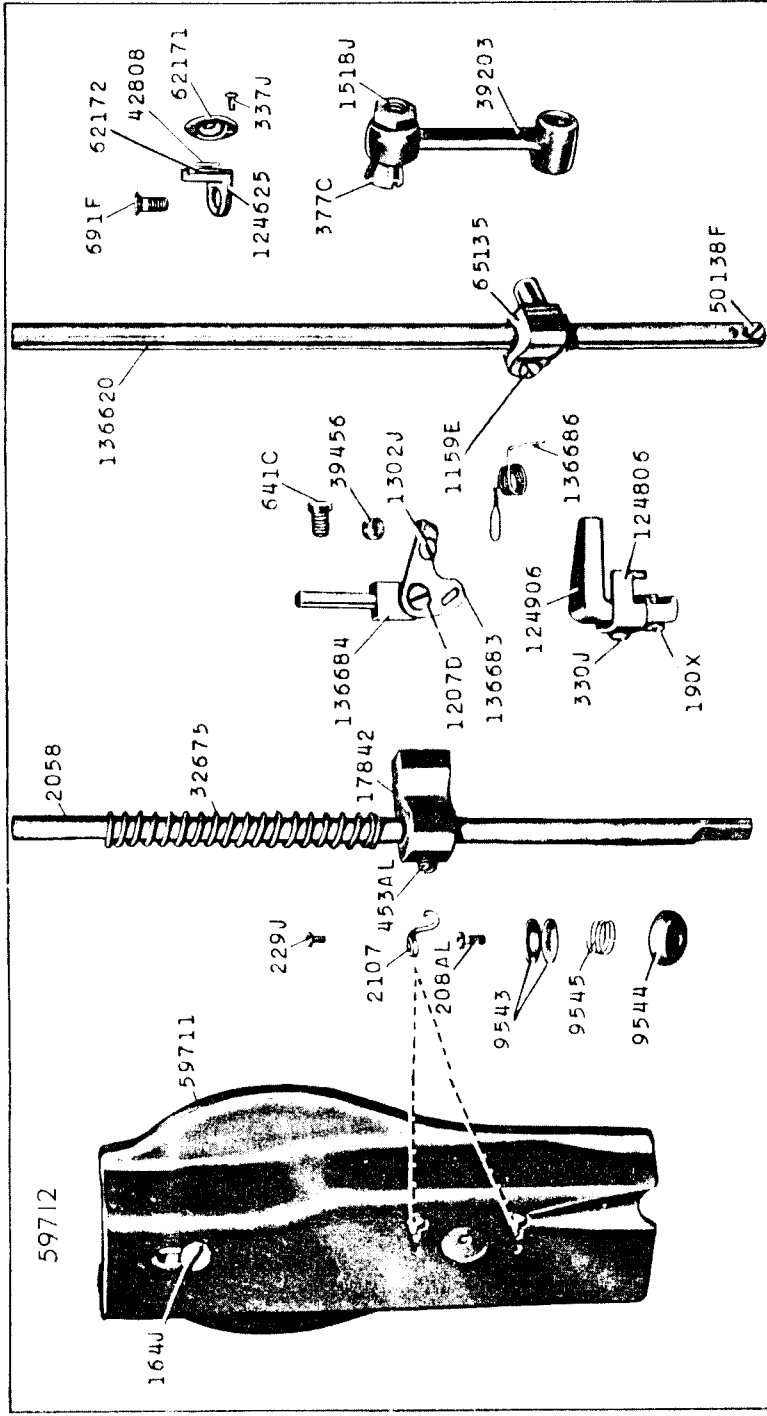

25270-1/3

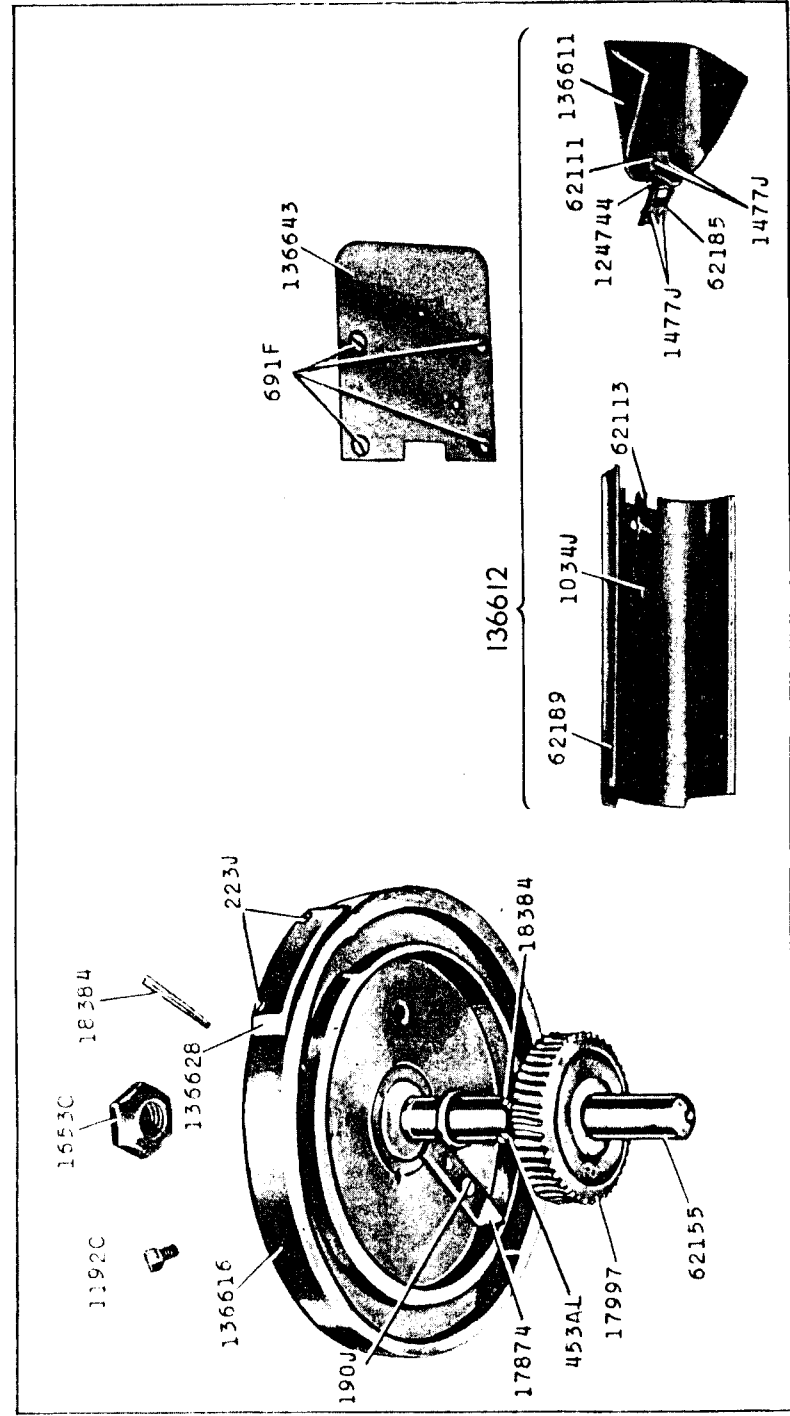

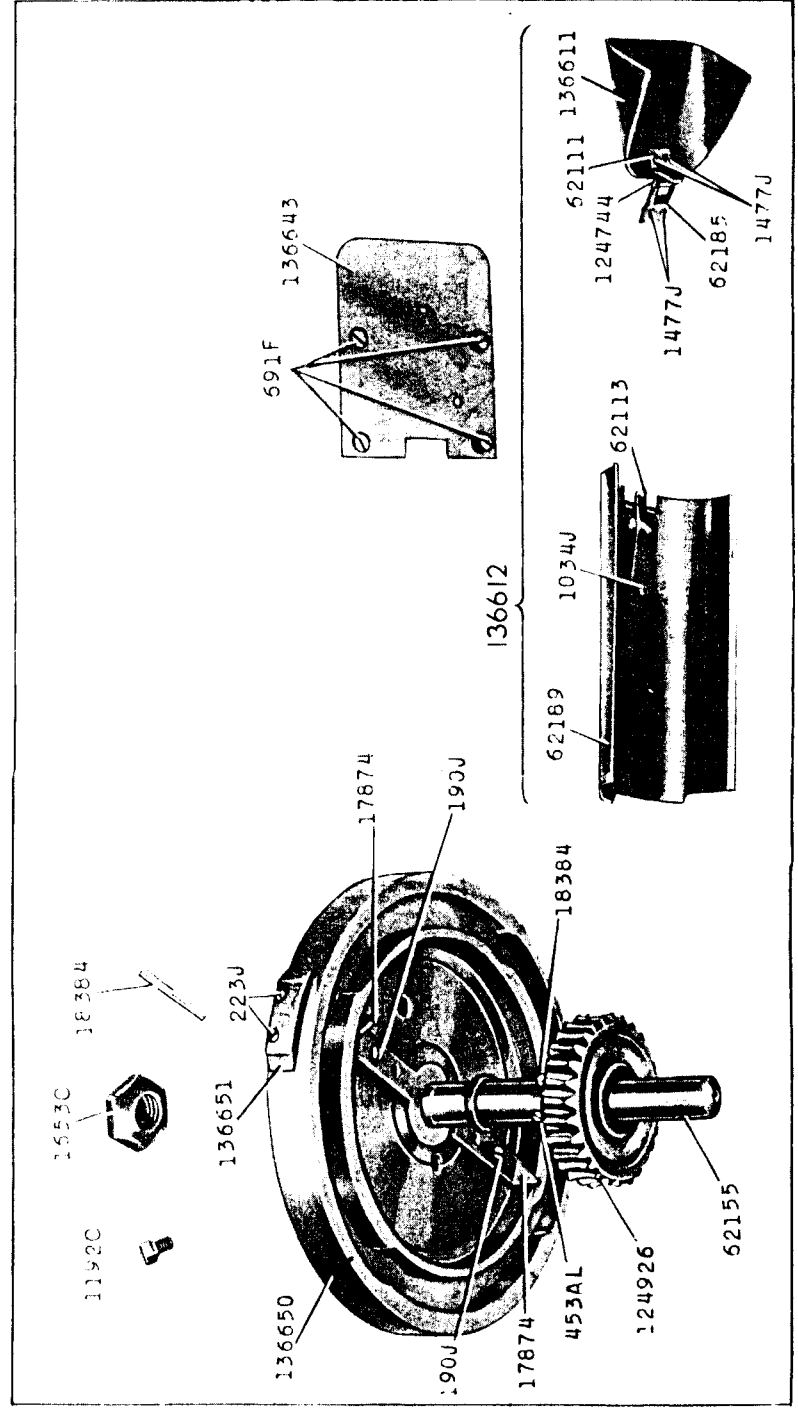
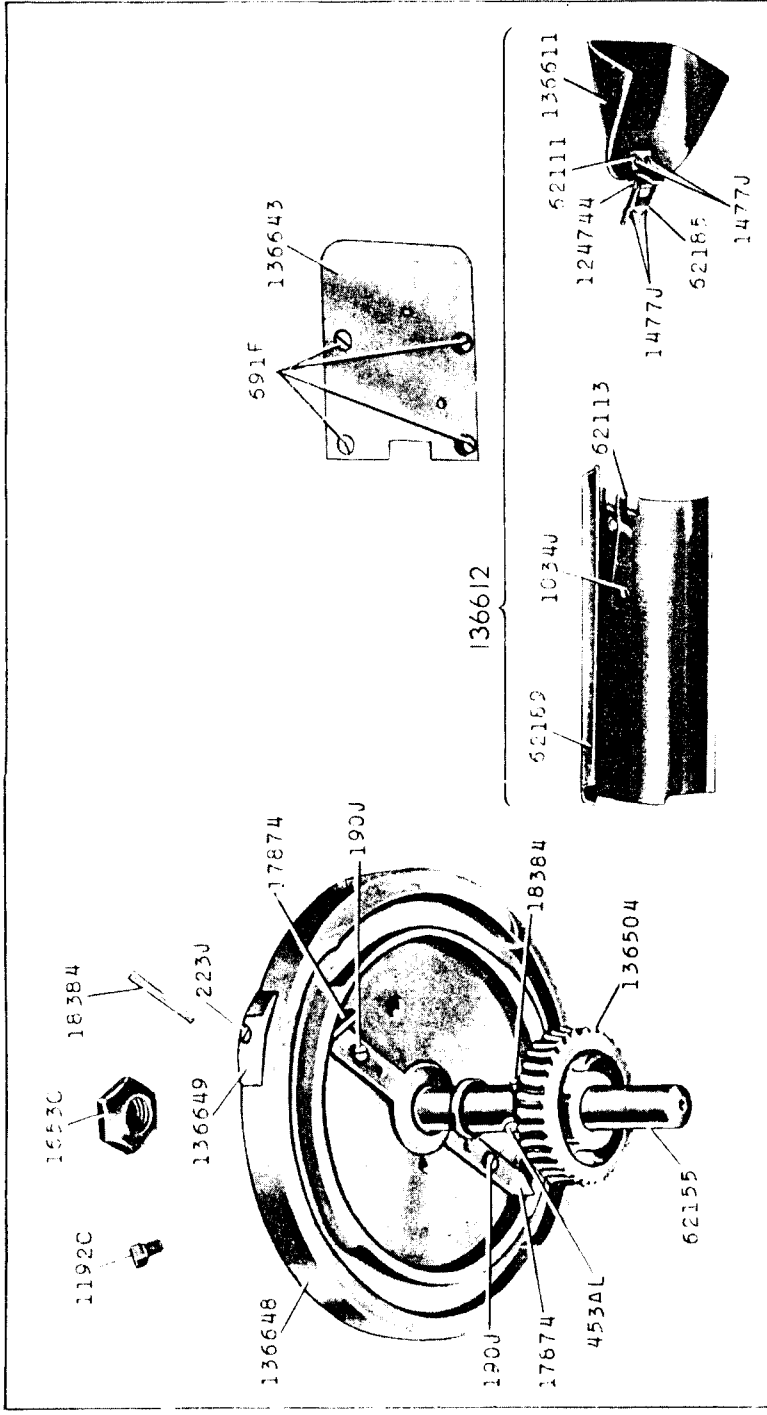

25273-1/3

114-53

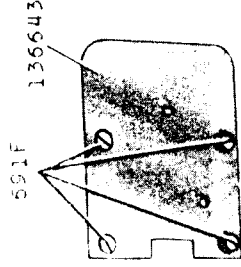
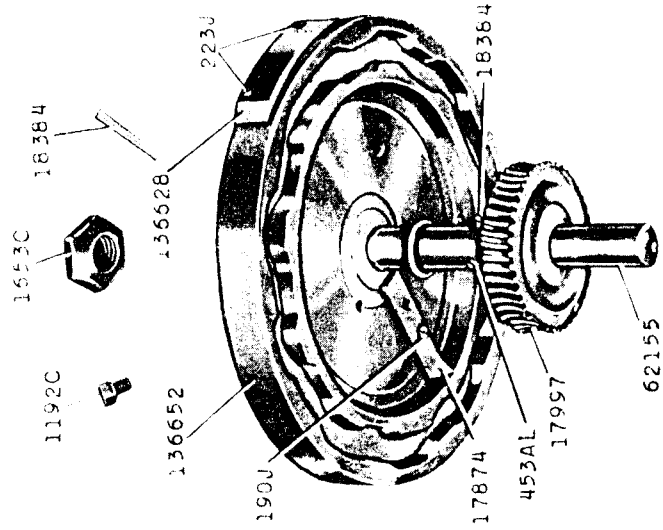

136612

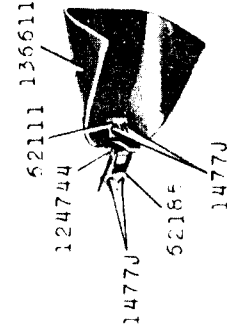
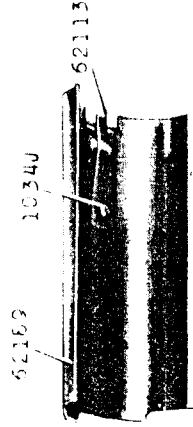

25274-1/3

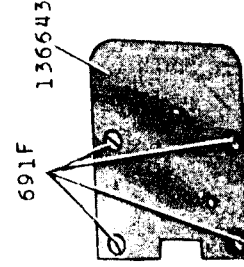
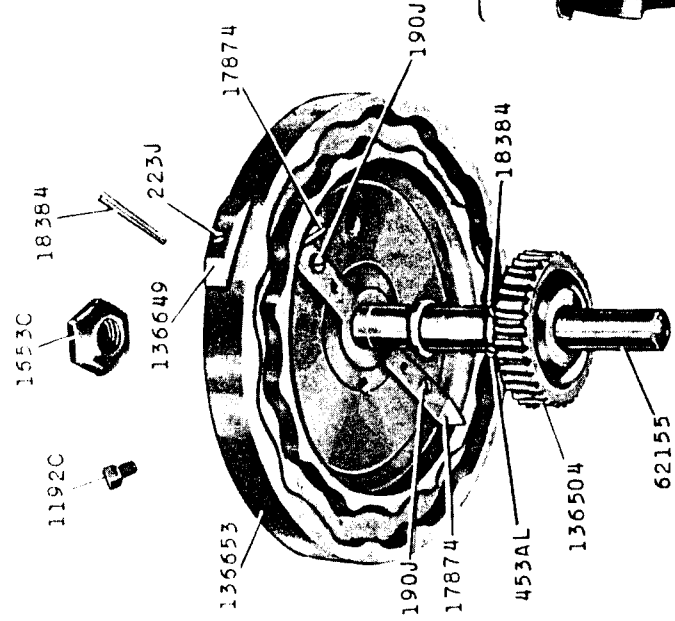

136612

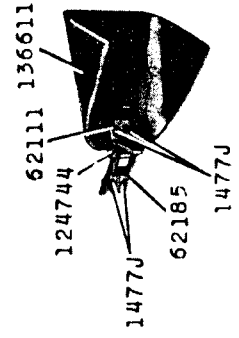
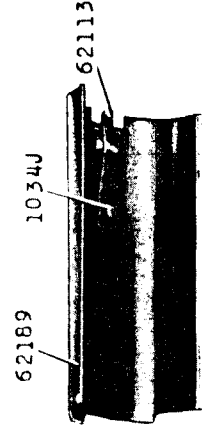

25275-1/3

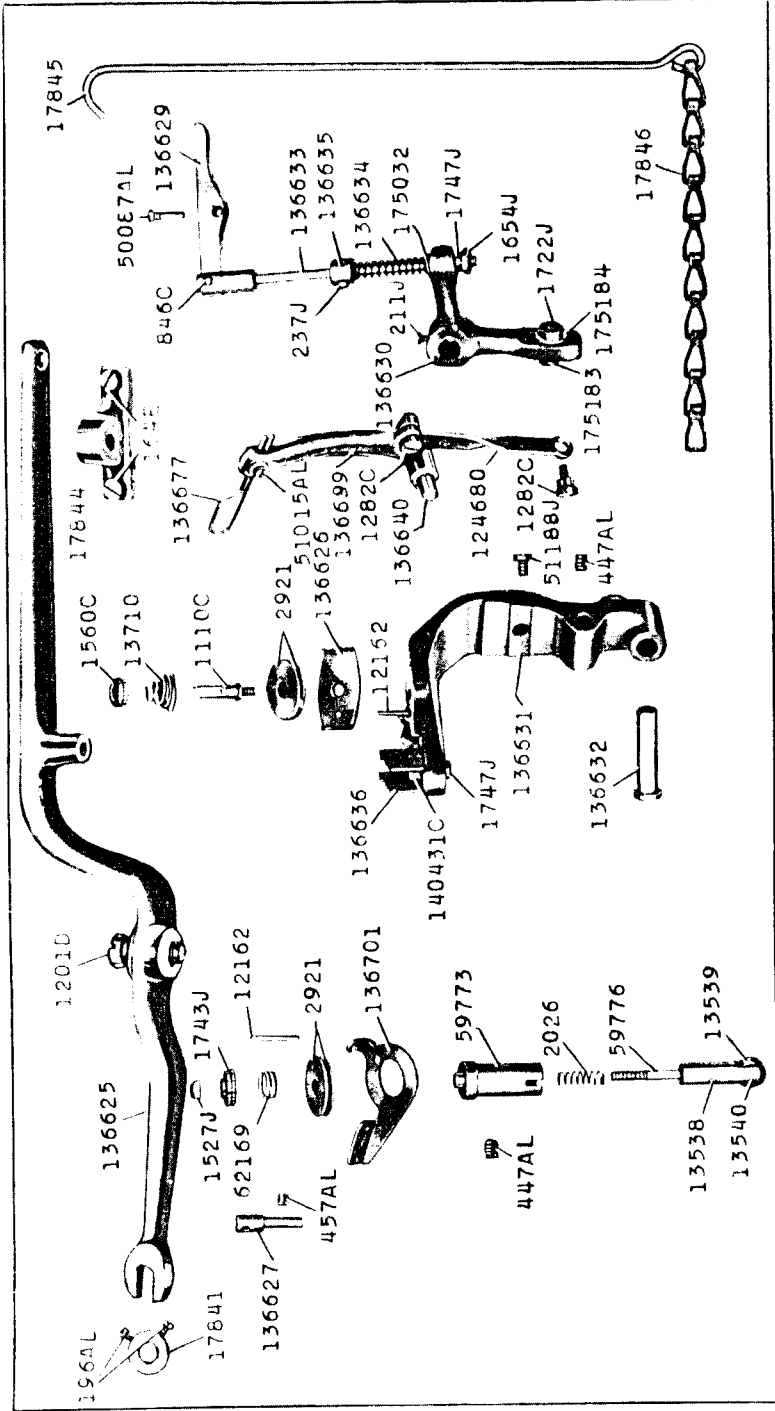

25276-1/3

