

MACHINE PARTS CHART
for
SINGER*

16U288

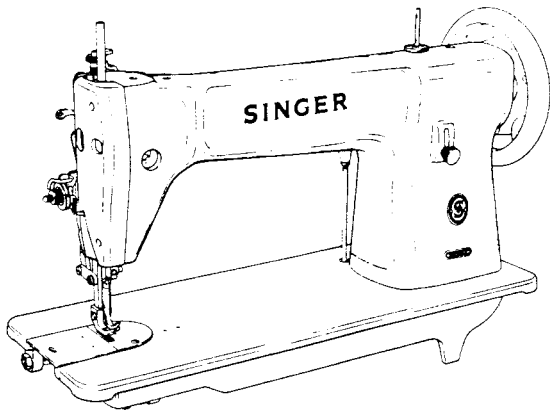

SINGER*

16U288

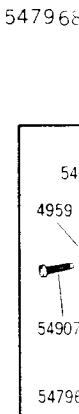
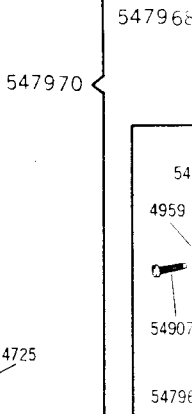
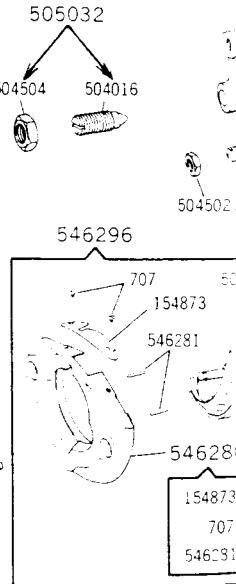
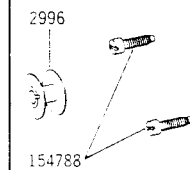
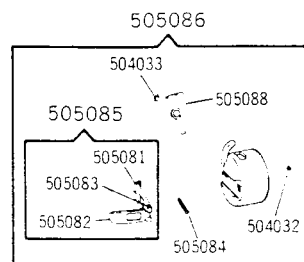
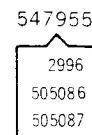
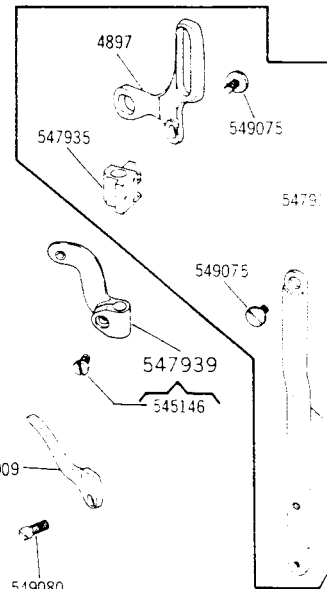
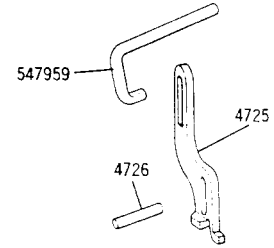
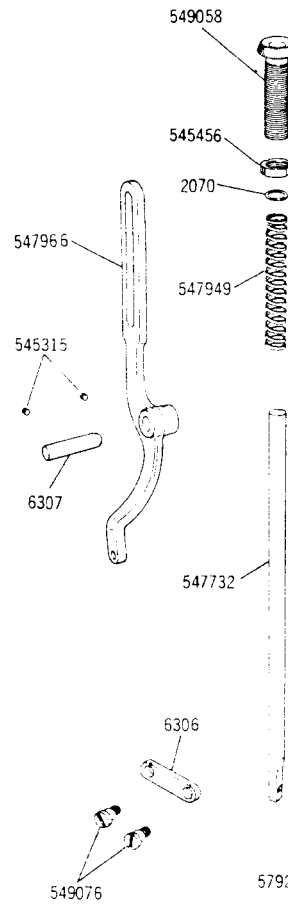
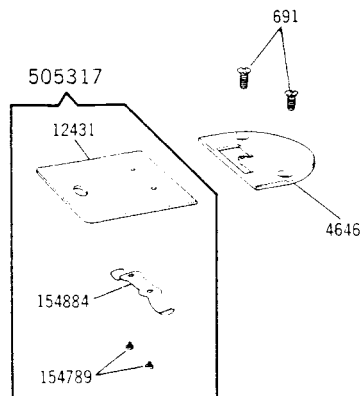
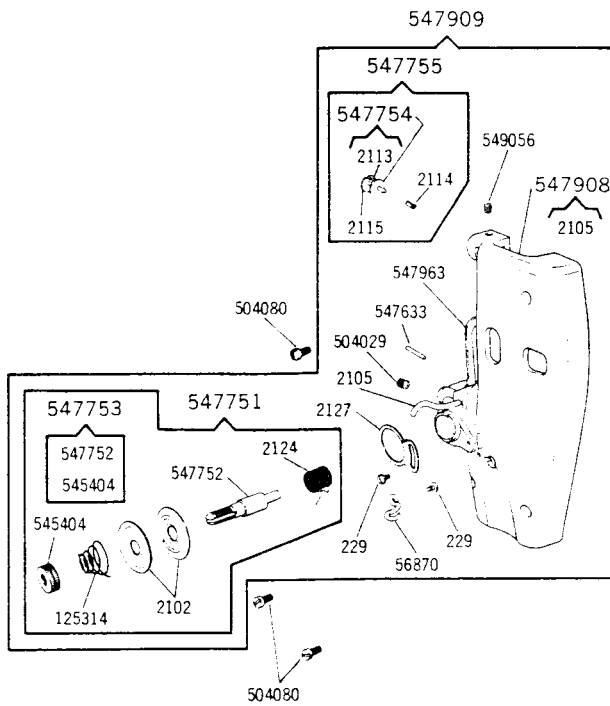

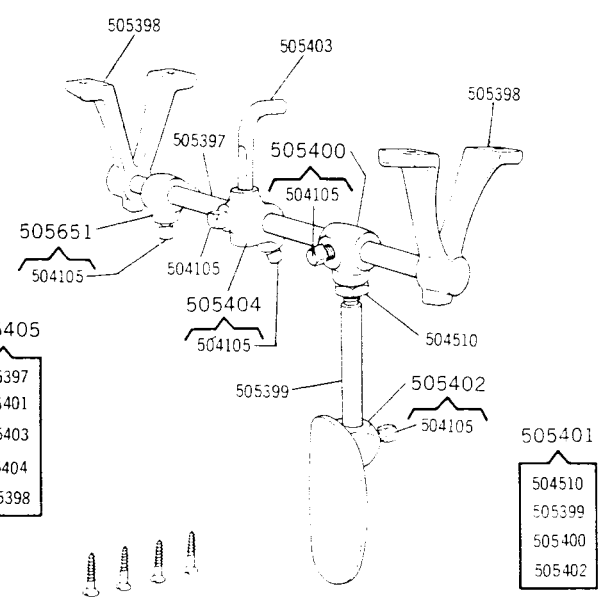
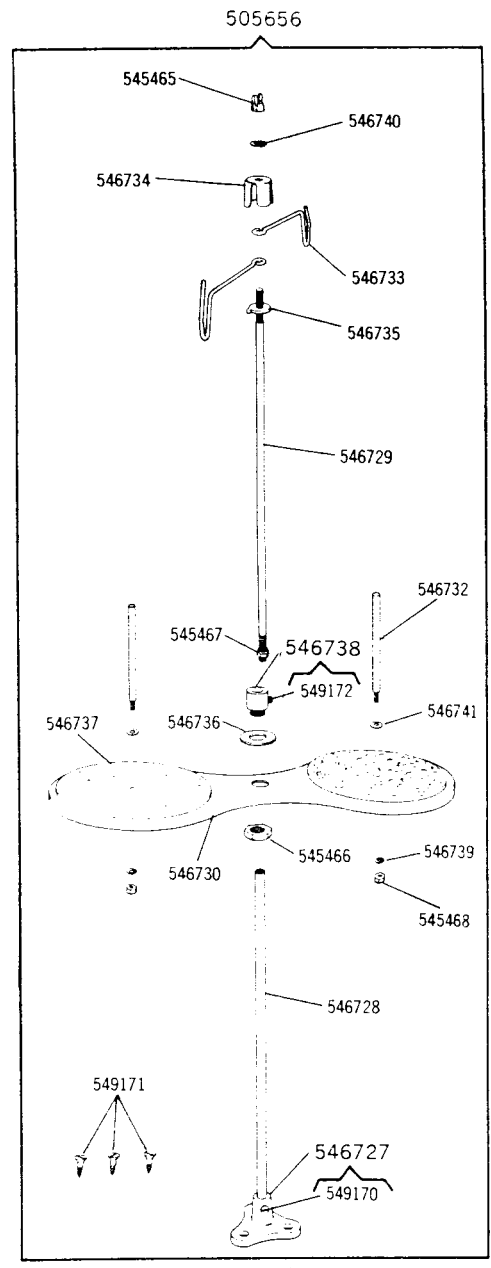
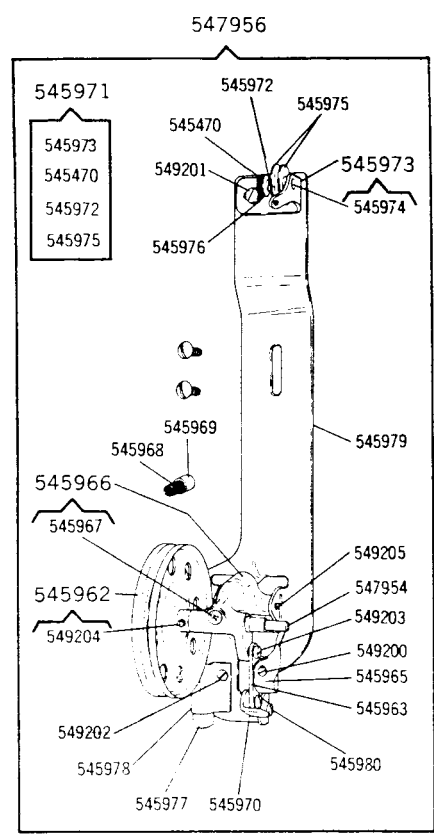
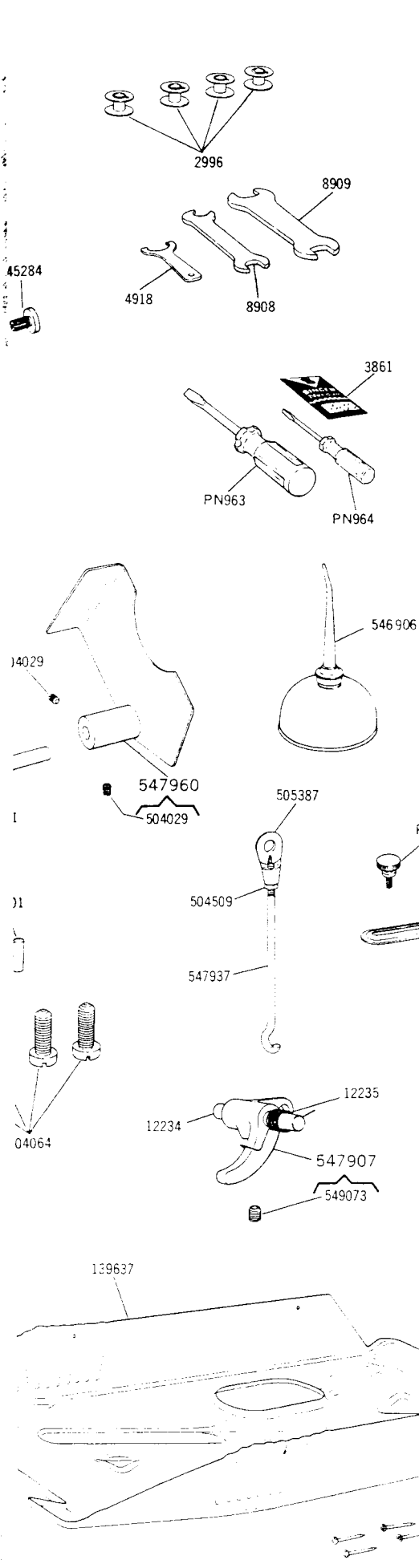

NUMERICAL LIST OF PARTS FOR MACHINE 16U288

PART NO.	DESCRIPTION	PART NO.	DESCRIPTION	PART NO.	DESCRIPTION
229 (809)	Face Plate Thread Guard Screw	154884	Shuttle Race Slide Spring	505086	Shuttle Bobbin Case complete, Nos. 504032 (805), 505084, 505085, 504033 (806) and 505088
229 (809)	Thread Take-up Spring Regulator Plate Adjusting Screw	154981 (819)	Crank Connecting Rod Hinge Screw Nut	505087	Shuttle (body)
691 (850)	Throat Plate Screw (2)	154981 (819)	Feed (lower) Connecting Link Hinge Screw Nut (2)	505088	Shuttle Tension Spring
707 (809)	Shuttle Race Cap Screw (2)	154981 (819)	Feed (lower) Forked Connection Hinge Screw Nut	505317	Shuttle Race Slide complete, Nos. 12431, 154884 and two 154789 (809)
2070	Lifting Presser Bar Spring Washer	504002 (850)	Arm Shaft Bushing (intermediate) Set Screw	505335	Feed (lower) Rock Shaft Crank with 504019 (808)
2102	Tension Disc (2)	504004 (852)	Arm Side Cover Thumb Screw	505387	Lifting Lever Connecting Rod Joint
2105	Tension Thread Guard	504016 (850)	Feed (lower) Lifting Rock Shaft Screw Center (2)	505407	Feed (lower) Bar Screw Center 504068 (803) with 504502 (819)
2113	Thread Retaining Disc Steady Pin	504016 (850)	Feed (lower) Rock Shaft Screw Center (2)	505632	Feed (lower) Lifting Rock Shaft Crank Block
2114	Thread Retaining Spring	504019 (808)	Feed (lower) Lifting Rock Shaft Crank Clamping Screw	505633	Feed (lower) Lifting Rock Shaft Crank Block Stud with 505632
2115	Thread Retaining Stud	504019 (808)	Feed (lower) Rock Shaft Crank Clamping Screw	545056 (833)	Oscillating Shaft Crank Set Screw
2124	Thread Take-up Spring	504029 (833)	Belt Safety Guard Set Screw (2)	545146 (809)	Lifting Presser Bar Bracket Clamping Screw
2127	Thread Take-up Spring Regulator Plate	504029 (833)	Feed (lower and upper) Cam Set Screw	545202 (850)	Shuttle Race Back Spring Thumb Screw
2362	Feed (upper) Bar Hinge Bracket Rivet (2)	504029 (833)	Lifting Lever Hook Set Screw	545232 (833)	Arm Shaft Bushing back Set Screw
2996	Shuttle Bobbin	504029 (833)	Tension Screw Stud Set Screw	545232 (833)	Thread Take-up Cam Set Screw
3165	Feed (lower) Lifting Rock Shaft	504032 (805)	Shuttle Bobbin Case Latch Stop Screw	545284 (802)	Arm Shaft Screw
3168	Oscillating Shaft	504032 (805)	Shuttle Tension Regulating Screw	545314 (810)	Lifting Presser Foot Screw
4266	Needle Clamp Thread Guide	504051 (850)	Feed Dog Screw (2)	545314 (810)	Feeding Foot Screw
4642	Feed Dog 15 teeth, 16 teeth to the inch	504056 (833)	Feed (upper) Forked Connection Set Screw	545315 (803)	Feed (upper) Lever Hinge Pin Set Screw (2)
4646	Throat Plate (large needle hole, for 4642)	504064 (805)	Arm Screw (4)	545318 (810)	Feed (upper) Regulator Thumb Screw Stop Bracket Screw (2)
4725	Lifting Presser Bar Lifting Bracket	504068 (803)	Feed (lower) Bar Screw Center (2)	545361 (803)	Guide Bar Driving Crank Wedge Screw
4726	Lifting Presser Bar Lifting Bracket Guide Pin	504071 (833)	Crank Connecting Rod Cap Screw (2)	545382 (850)	Machine Pulley Set Screw (2)
4897	Lifting Presser Bar Lifting Bell Crank	504080 (851)	Face Plate Screw (3)	545404 (856)	Tension Regulating Thumb Nut
4907	Feed (upper) Regulator Thumb Screw Stop Bracket	504100 (809)	Lifting Lever Connecting Rod Joint Hinge Screw	545456 (851)	Pressure Regulating Thumb Screw Lock Nut
4909	Lifting Presser Bar Lifter	504101 (830)	Belt Safety Guard Shaft Set Screw	546280	Shuttle Race with 154873 and two each 707 (809) and 546281
4959	Feed (upper) Regulator Thumb Screw Stud (brass)	504502 (819)	Feed (lower) Bar Screw Center Nut (2)	546281	Shuttle Race Back Position Pin (2)
5792	Lifting Presser foot	504504 (819)	Feed (lower) Rock Shaft Screw Center Nut (2)	546282	Shuttle Race Back
6306	Feed (upper) Bar Connecting Link	504504 (819)	Oscillating Rock Shaft Hinge Pin Bushing Nut	546283	Shuttle Race Back Spring
6307	Feed (upper) Lever Hinge Pin	504504 (819)	Oscillating Rock Shaft Hinge Pin Nut	546285	Shuttle Race complete, Nos. 545202 (850), 546280, 546282 and 546283
12234	Bell Crank Shaft	504504 (819)	Feed (lower) Lifting Rock Shaft Screw Center Nut (2)	546296	Shuttle Race 546285 and 505087
12235	Bell Crank Spring	504509 (809)	Lifting Lever Connecting Rod Lock Nut	546423	Feed (upper) Forked Connection Pin
12424	Oscillating Shaft Crank Slide Block Cap Screw Washer	505001	Arm Dowel Pin (2)	547633	Tension Releaser Hinge Pin
12431	Shuttle Race Slide	505008	Arm Spool Pin Washer (felt)	547707	Crank Connecting Rod with 125044 and two 504071 (833)
52165	Feed (lower) Connecting Link	505032	Feed (lower) Rock Shaft Screw Center 504016 (850) with 504504 (819)	547720	Machine Pulley with two 545382 (850)
52239	Arm Spool Pin and Thread Eyelet	505032	Feed (lower) Lifting Rock Shaft Screw Center 504016 (850) with 504504 (819)	547721	Needle Bar
56829	Thread Take-up Cam	505081	Shuttle Bobbin Case Latch	547723	Needle Bar Connecting Stud with 154777 (850)
56870	Face Plate Thread Guard	505082	Shuttle Bobbin Case Latch Lever	547732	Lifting Presser Bar
56896	Feeding Foot	505083	Shuttle Bobbin Case Latch Lever Fulcrum Pin	547751	Tension complete, Nos. 125314, 2124, 547753 and two 2102
125044	Crank Connecting Rod Oil Pad felt	505084	Shuttle Bobbin Case Latch Spring	547752	Tension Screw Stud
125314	Tension Spring	505085	Shuttle Bobbin Case Hinge Nos. 505081, 505082 and 505083		
139603	Feed (lower) Regulator Hinge Screw Friction Washer				
154759 (850)	Crank Connecting Rod Hinge Screw				
154759 (850)	Feed (lower) Connecting Link Hinge Screw (2)				
154759 (850)	Feed (lower) Forked Connection Hinge Screw				
154777 (850)	Needle Bar Connecting Stud Set Screw				
154788 (819)	Shuttle Race Screw (2)				
154789 (809)	Shuttle Race Slide Spring Screw (2)				
154873	Shuttle Race Cap				

NUMERICAL LIST OF PARTS FOR MACHINE 16U288

PART NO.	DESCRIPTION
504105 (809)	Rock Shaft Knee Plate Set Screw
505403	Rock Shaft Lifting Arm
505404	Rock Shaft Lifting Arm Hub with two 504105 (809)
504105 (809)	Rock Shaft Lifting Arm Hub Set Screw
504105 (809)	Rock Shaft Lifting Arm Set Screw
505651	Rock Shaft Stop Dog with 504105 (809)
504105 (809)	Rock Shaft Stop Dog Set Screw
	Wood Screw 1" No. 9 (4)

BOBBIN WINDER

547956	Universal Bobbin Winder complete, Nos. 545962, 545963, 545965, 545966, 545968, 545969, 545970, 545971, 545976, 545977, 545978, 545979, 547954, 549200 (819), 549201 (819), 549202 (819), 549203 (819), 549205 and two 545980 with two 5.5 x 19 Wood Screws
545979	Bobbin Winder and Tension Bracket Base
545977	Bobbin Winder Brake
545978	Bobbin Winder Brake Clamp
549202 (819)	Bobbin Winder Brake Clamp Screw
545966	Bobbin Winder Frame with 545967
549205	Bobbin Winder Frame Hinge Pin
545967	Bobbin Winder Frame Oil Cup
545968	Bobbin Winder Frame Spring
545969	Bobbin Winder Frame Spring Plunger
545962	Bobbin Winder Pulley with 549204 (819)
549204 (819)	Bobbin Winder Pulley Set Screw
547954	Bobbin Winder Spindle
545965	Bobbin Winder Stop Latch
549200 (819)	Bobbin Winder Stop Latch Screw
545970	Bobbin Winder Stop Latch Thumb Lever
545980	Bobbin Winder Stop Latch Thumb Lever Hinge Stud (2)
545963	Bobbin Winder Stop Latch Trip Lever
549203 (819)	Bobbin Winder Stop Latch Trip Lever Hinge Screw
545973	Bobbin Winder Tension Bracket with 545974
545971	Bobbin Winder Tension complete, Nos. 545470 (819), 545972, 545973 and two 545975
549201 (819)	Bobbin Winder Tension Bracket Screw
545976	Bobbin Winder Tension Bracket Screw Washer
545975	Bobbin Winder Tension Disc (2)
545972	Bobbin Winder Tension Spring
545974	Bobbin Winder Tension Stud

PART NO.	DESCRIPTION
545470 (819)	Bobbin Winder Tension Stud
	Thumb Nut
	Wood Screw 5.5 x 19 (2)

THREAD UNWINDER

505656	Thread Unwinder (for two spools) complete, Nos. 545465 (856), 545466 (856), 545467 (856), 546727, 546728, 546729, 546730, 546734, 546735, 546736, 546738, 546740, three 549171 and two each 545468 (856), 546732, 546733, 546737, 546739 and 546741
546732	Thread Unwinder Spool Pin (2)
545468 (856)	Thread Unwinder Spool Pin Nut (2)
546739	Thread Unwinder Spool Pin Spring Washer (2)
546741	Thread Unwinder Spool Pin Washer (2)
546738	Thread Unwinder Spool Rest Bushing with 549172 (850)
545466 (856)	Thread Unwinder Spool Rest Bushing Nut
546736	Thread Unwinder Spool Rest Bushing Nut Washer
549172 (850)	Thread Unwinder Spool Rest Bushing Set Screw
546737	Thread Unwinder Spool Rest Felt (2)
546730	Thread Unwinder Spool Rest (for two spools)
546728	Thread Unwinder Spool Rest Rod lower
549170 (828)	Thread Unwinder Spool Rest Rod lower Set Screw
546729	Thread Unwinder Spool Rest Rod upper
545467 (856)	Thread Unwinder Spool Rest Rod upper Nut
546727	Thread Unwinder Spool Stand with 549170 (828)
546733	Thread Unwinder Thread Guide (2)
545465 (856)	Thread Unwinder Thread Guide Lock Nut
546740	Thread Unwinder Thread Guide Lock Nut Spring Washer
546734	Thread Unwinder Thread Guide Position Cup
546735	Thread Unwinder Thread Guide Rod Washer
549171	Wood Screw No. 10 x 1 inch (3)