

**SINGER**  
**410W110**

Form 3026w  
(350)  
Printed in U. S. A.

# SINGER\*\*

## 410w110



\*\* A TRADE MARK OF

THE SINGER MANUFACTURING COMPANY

18280 - 1/2



Copyright, U. S. A., 1941, 1942, 1946 and 1950  
by The Singer Manufacturing Co.  
All Rights Reserved for all Countries

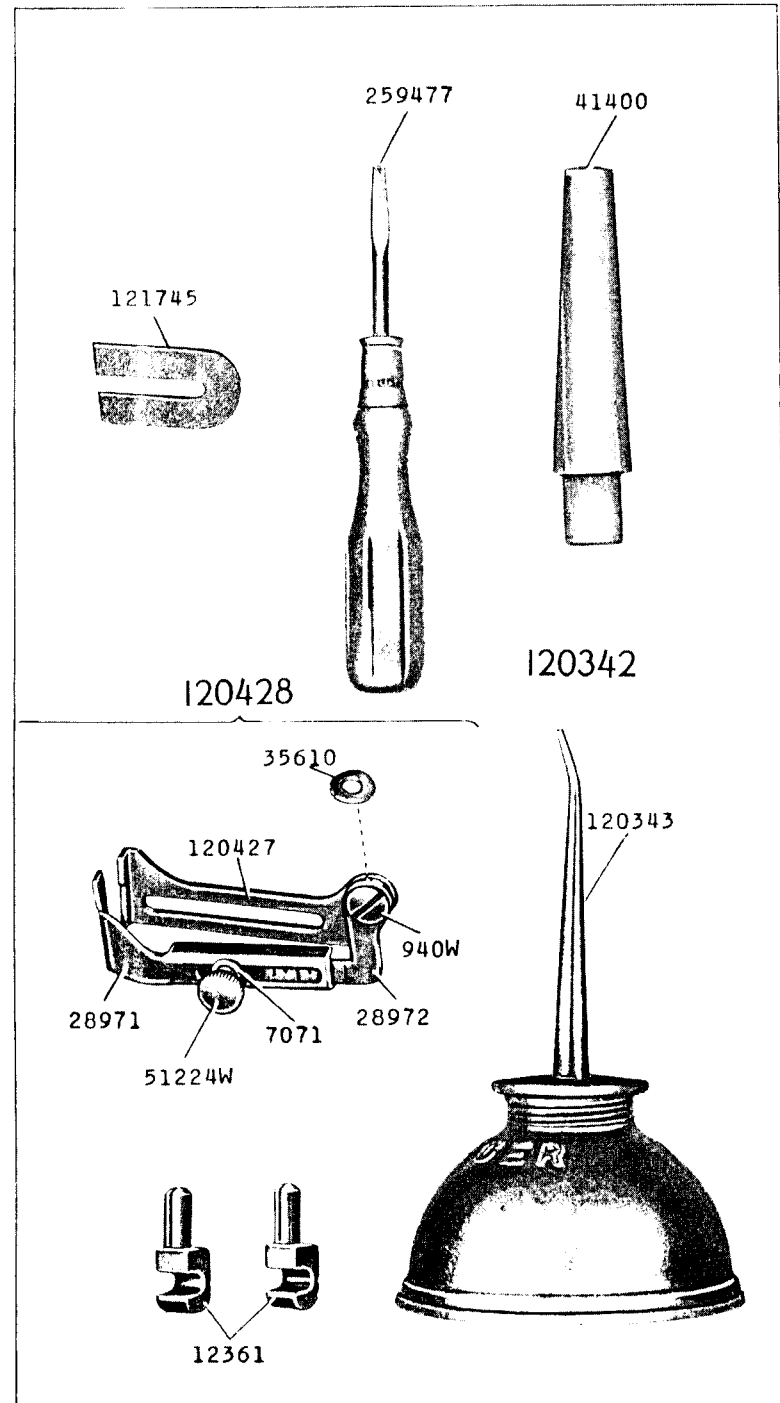

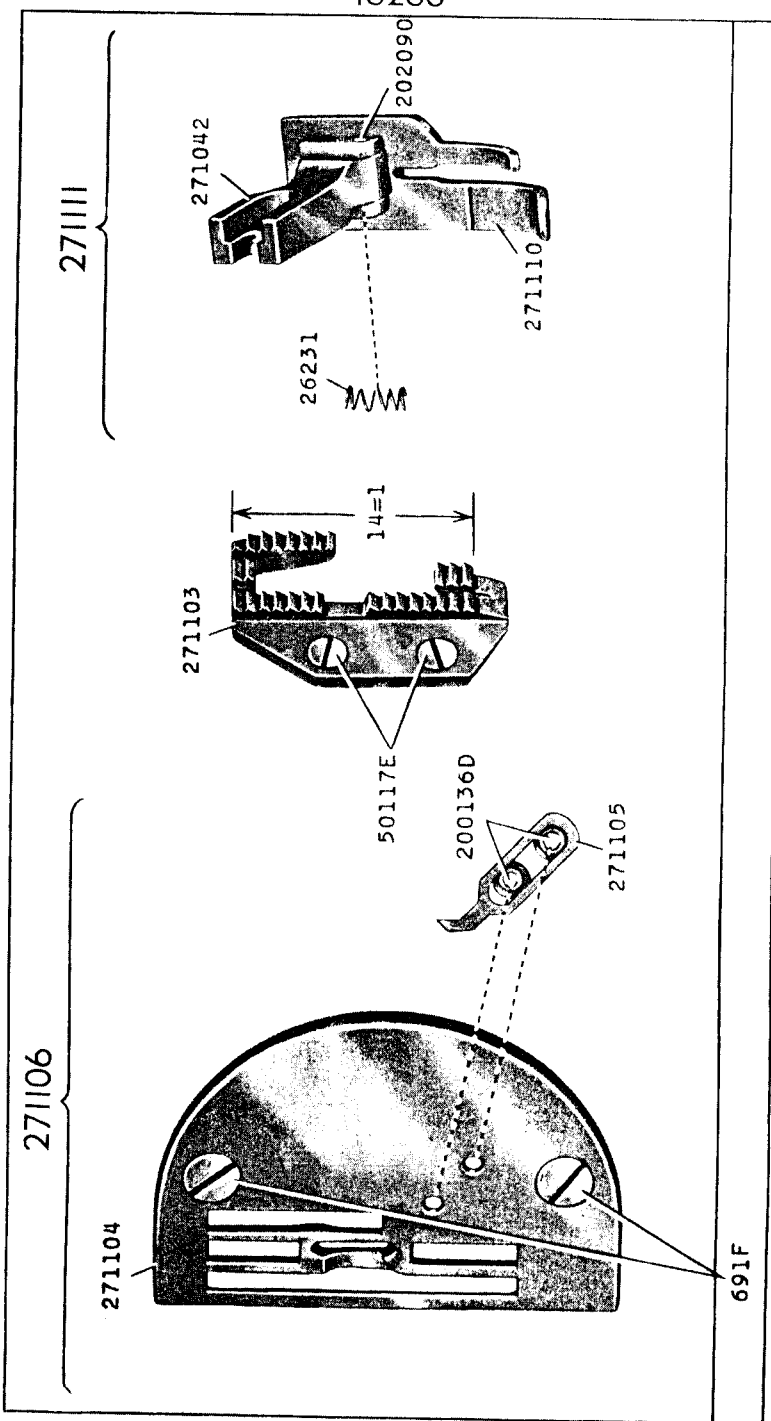

18286

18332 - 3/8

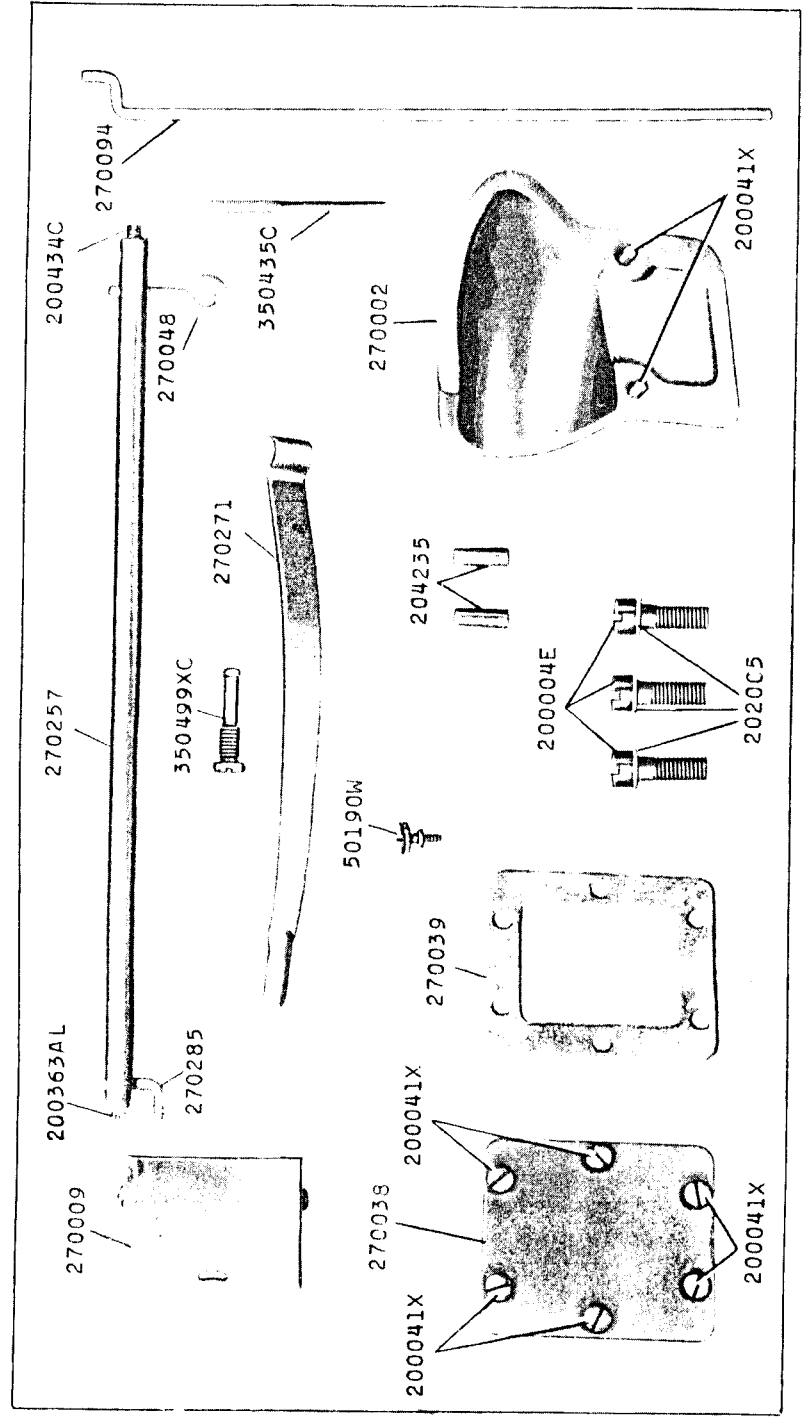

18333 - 1/4

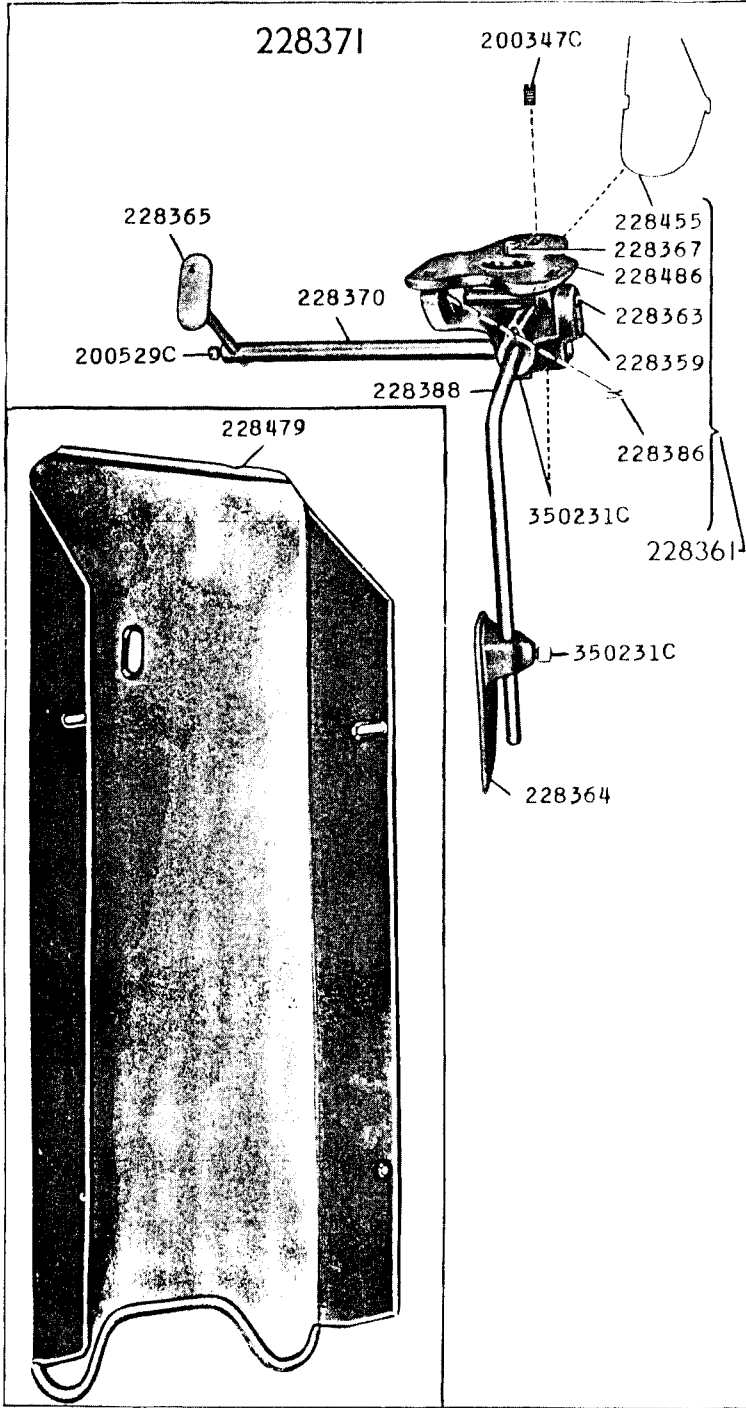

18454 - 1/2

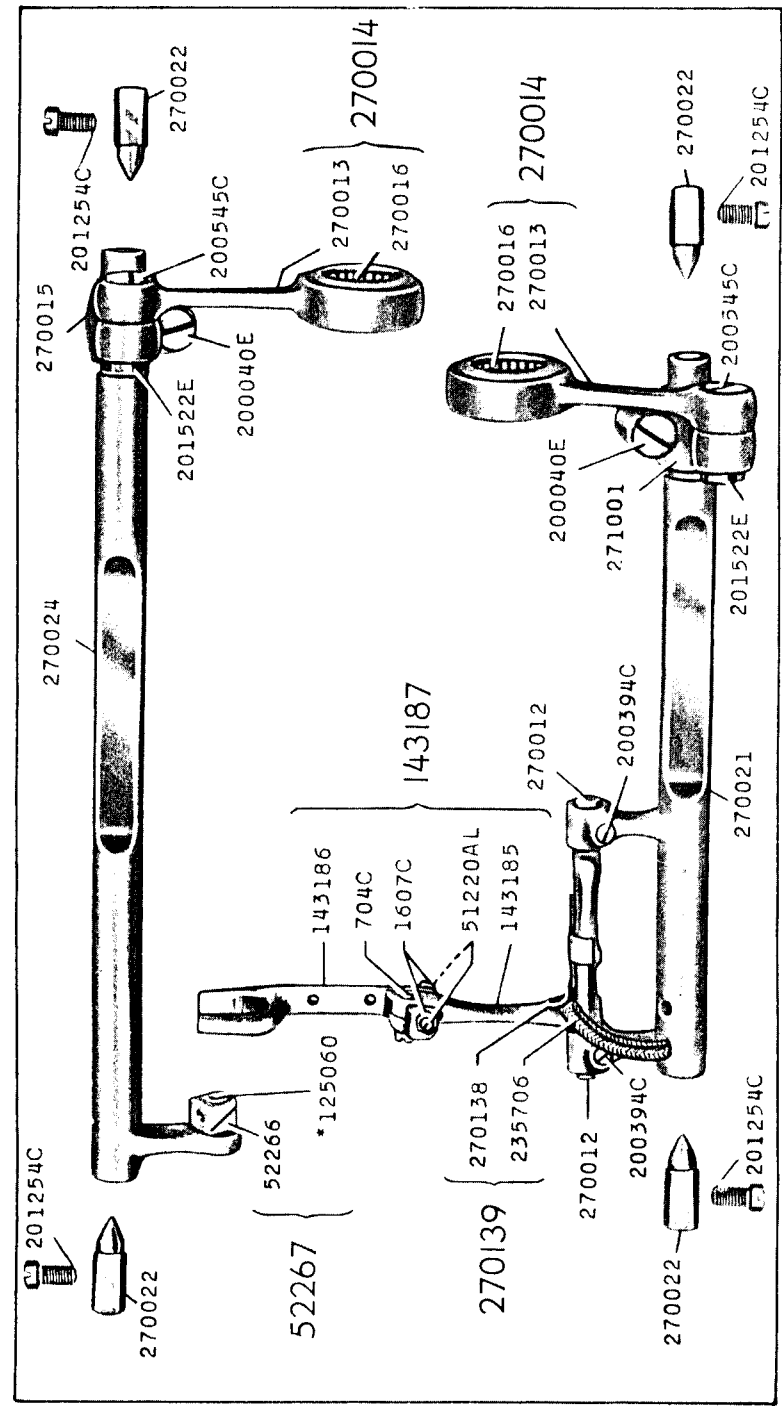

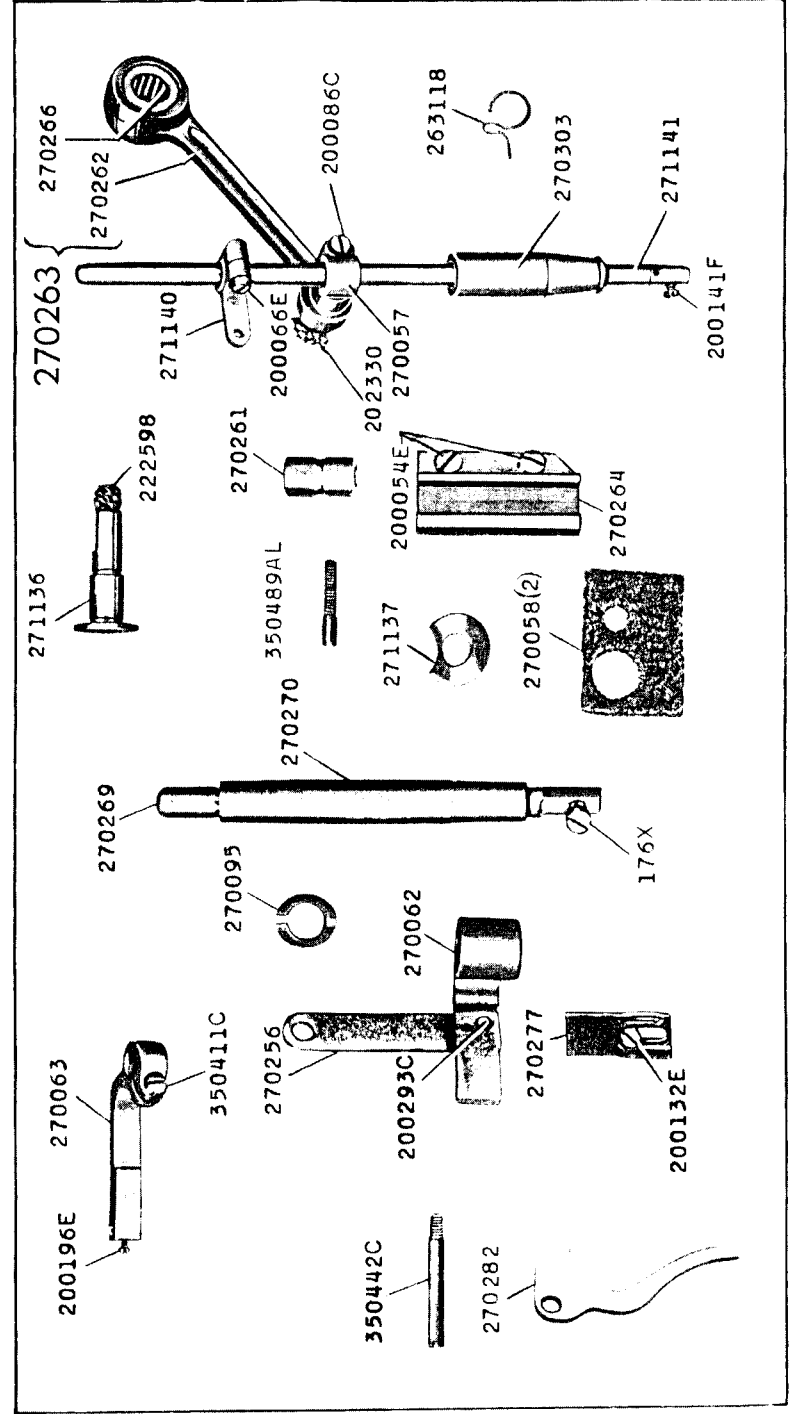
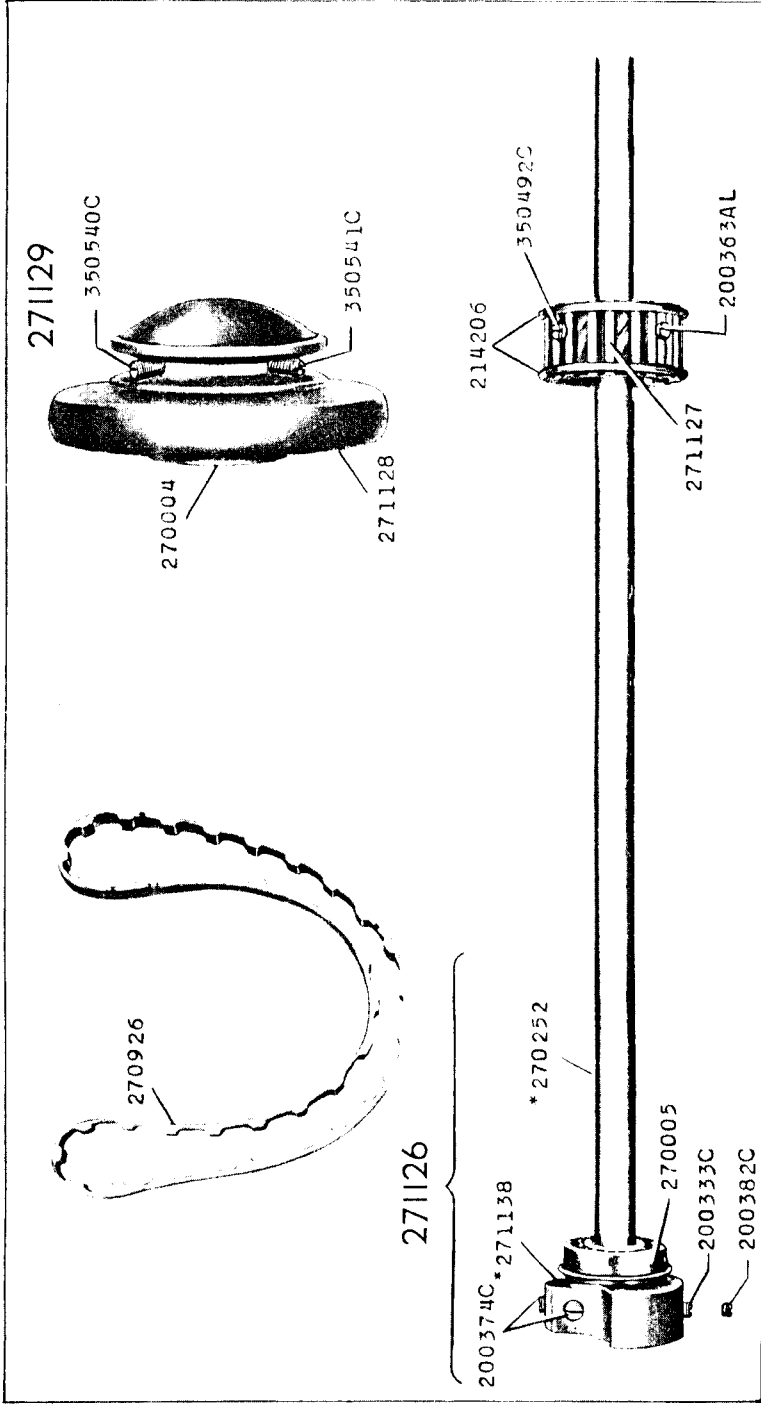

18457 - 1/2

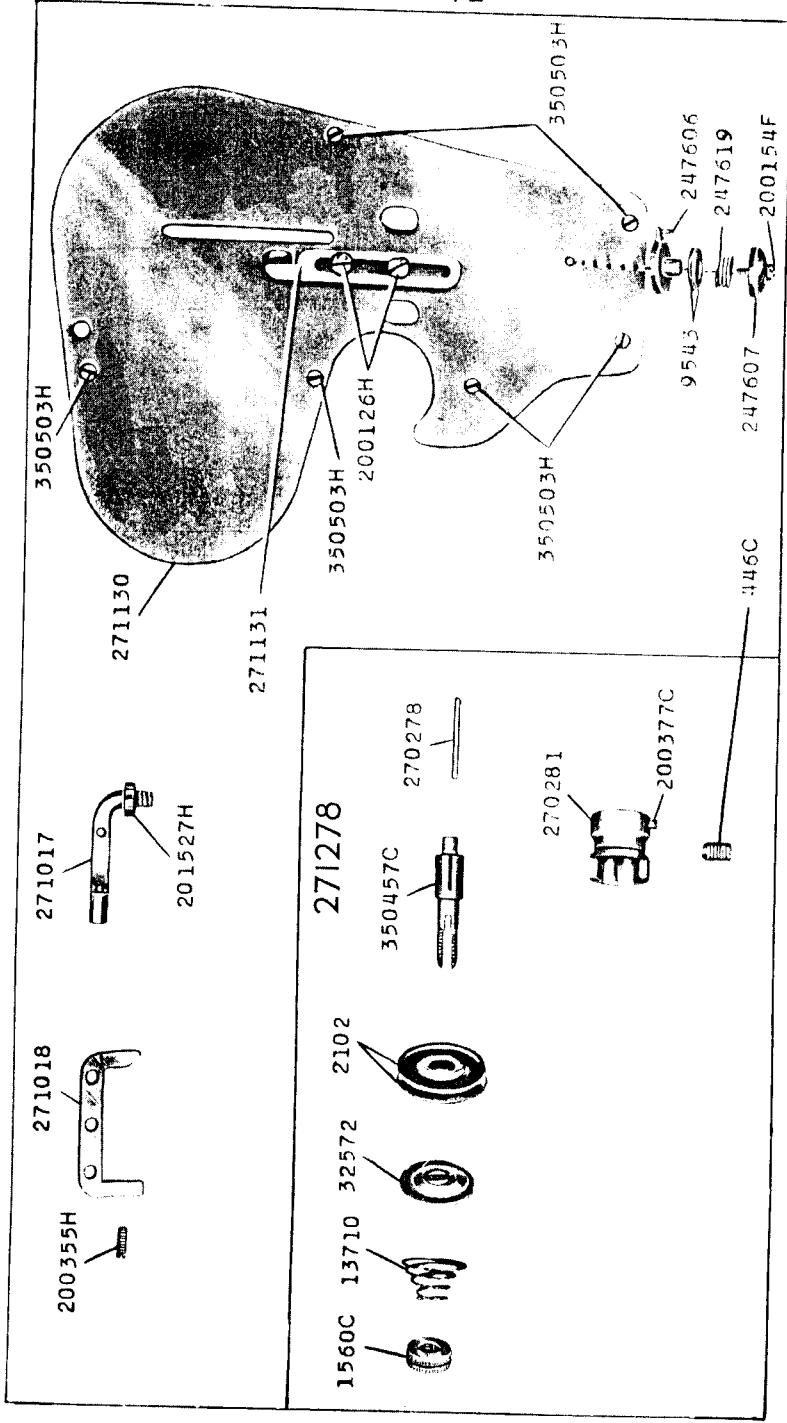

18458 - 3/8

