

# Service Manual for

211 G 155 / G 156

Property of  
THE SINGER COMPANY  
Industrial Products Division  
Adv. & Sales Promotion Dept.  
561 Broadway - N.Y. 12 ~~AF~~



*Sewing Equipment  
For Industry*

SERVICE MANUAL  
FOR  
**SINGER**  
SEWING MACHINES

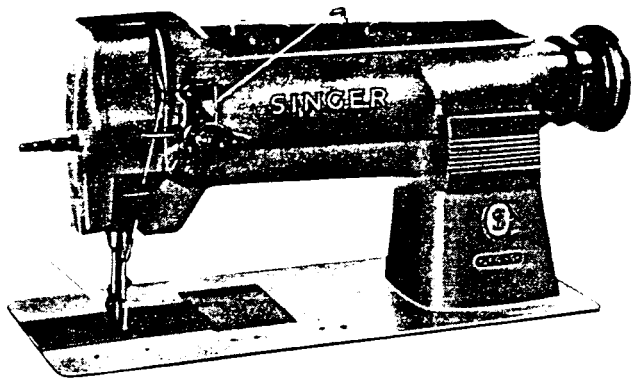

211 G 155

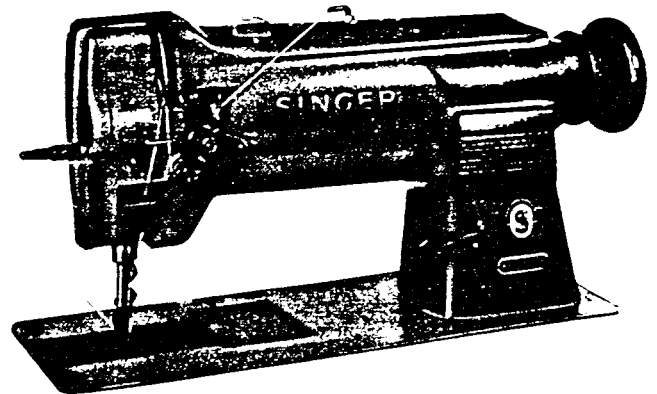

211 G 156

## CONTENTS

	Page
Description . . . . .	3
Speed . . . . .	3
Installation of the machine . . . . .	4
Lubrication . . . . .	4
Needles . . . . .	5
Thread . . . . .	5
Bobbin removal . . . . .	5
To wind the bobbin . . . . .	6
Bobbin replacement . . . . .	6
To set the needle . . . . .	6
Threading of needle thread . . . . .	6
Preparation for sewing . . . . .	7
Adjustment of thread lubrication . . . . .	7
Tension control . . . . .	7
<b>Adjustment of stitch length</b> . . . . .	7
Regulation of presser foot pressure . . . . .	8
Reengagement of safety clutch . . . . .	8
To use the reverse feed on the 211 G 156 machine . . . . .	8
Adjustment of the thread controller spring . . . . .	8
Adjustment of tension release . . . . .	8
Adjustment of needle bar rock frame . . . . .	8
Adjustment of height of needle bar . . . . .	9
Adjustment of the hook . . . . .	10
Replacement of hook . . . . .	11
Feed dog adjustment . . . . .	11
Adjustment of the presser bar height . . . . .	11
Adjustment of the lifting eccentric and the lift of the alternating presser feet . . . . .	11
Adjustment of the feed driving eccentric . . . . .	11
Adjustment of the reverse feeding mechanism on the 211 G 156 machine . . . . .	12
Replacement of arm shaft connection belt . . . . .	12

---

## DESCRIPTION

---

**The 211 G 155 MACHINE** is a single needle, lockstitch, high speed sewing machine with compound feed and alternating presser feet. It is suitable for automobile and furniture upholstery, awnings, tarpaulins, leather coats, buffing wheels, and other difficult work.

The machine has the following specifications:

1. Needle Bar Stroke:  $1\text{-}\frac{5}{16}$  inches = 33,40 mm  
Clearance under Presser Foot:  $\frac{1}{2}$  inch = 12,70 mm  
Space at Right of Needle:  $10\text{-}\frac{1}{2}$  inches = 266,70 mm  
Maximum Stitch Length:  $3\text{-}\frac{1}{2}$  stitches/inch = 7,25 mm/Stich  
Bed Dimensions:  $18\text{-}\frac{3}{4}$  x 7 inches = 476,25 x 177,80 mm  
Machine Pulley (Safety Type) for  $\frac{3}{8}$  inch V-Belt = 9,50 mm  
Outside diameter of belt groove 2.9 inches = 73,65 mm  
Effective diameter for  $\frac{5}{16}$  inch round belt is  $2\text{-}\frac{3}{8}$  inches = 60,30 mm  
Head End Location for Singer Light No. 625024-504
2. Adjustable thread lubrication.
3. Sleeve take-up.
4. Vertical axis hook, with rigid needle guard, makes two (2) revolutions for each stitch.
5. Safety clutch to prevent any overload or damage of the hook.
6. Needle Feed is adjustable relative to the lower feeding mechanism.
7. Alternating presser feet, adjustable by means of a lifting eccentric.
8. Stitch length indicated on the machine pulley and controlled by means of an adjustable feed driving eccentric.
9. Arm shaft and bed shaft are supported on the driven side by double-shielded ball bearings. The needle bar frame rock shaft and the feed driving rock shaft are equipped with "Super Oilite" bearings. The feed driving eccentric connection has needle bearings.

**The 211 G 156 MACHINE** is the same as the 211 G 155 machine except that

the machine is provided with a reverse feed which can be actuated by hand lever or foot treadle;

the maximum stitch length is 5 stitches/inch;

the needle feed is set synchronous with the lower feed mechanism;

the arm shaft and the bed shaft are supported on the driven side by double-shielded ball bearings. The needle bar frame rock shaft, the feed driving rock shaft, and the feed driving eccentric connection are equipped with "Super Oilite" bearings.

---

## SPEED

---

The recommended maximum speed for the 211 G 155 MACHINE is 3500 RPM and that for the 211 G 156 MACHINE is 2900 RPM. The speed depends on the type of material being sewn and on the method of sewing. At first the machine should be run below the maximum speed until all the movable parts and bearings are run in.

**CAUTION:** The machine pulley must always turn over toward the operator when the machine is in operation.

## INSTALLATION OF THE MACHINE (Figure 1)

Before the machine is placed in the table top, the oil pan "A", Fig. 1, should be attached in the table top cutout, so that its left end is even with the left end of the cutout. The knee lifter bracket "B" is assembled as

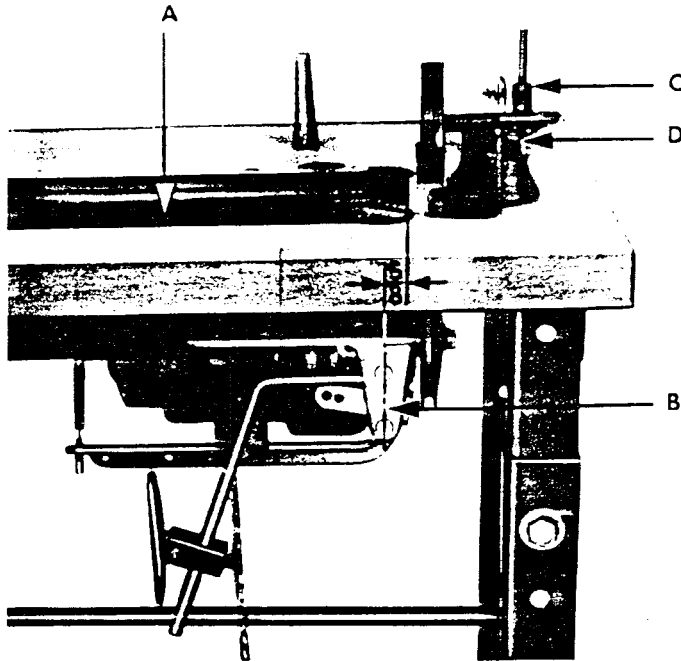

Figure 1

shown in Figure 1 and the knee lifter chain is attached to the knee lifter lever after the machine has been placed in the table top. The thread unwinder "D" is attached to the table top so that, if the engagement lever "E", Fig. 9, is depressed, the bobbin winder drive wheel is driven by the machine belt.

**CAUTION:** The machine should not be put in operation, even for a trial, unless all the instructions for the lubrication of the machine are observed.

## LUBRICATION (Figures 2 — 6)

For the lubrication of the machine, only Singer Oil "Type A or C", supplied by The Singer Company, should be used. In order to insure proper function of the machine and to prevent any excess wear of the moving parts and bearings, the machine should be oiled regularly. In case of continuous use, it should be oiled even more often if it is used to produce long seams and run steadily. All the arrows marked "F", "G" and "H" as well as the unmarked arrows in Figures 2 — 6 are lubrication points.

Figure 2 shows the machine head with the lubrication points "F" when the face plate has been removed. These lubrication points must be oiled in addition to all the other points before the machine is placed in operation for the first time.

Figure 3 shows the back of the machine with various lubrication points.

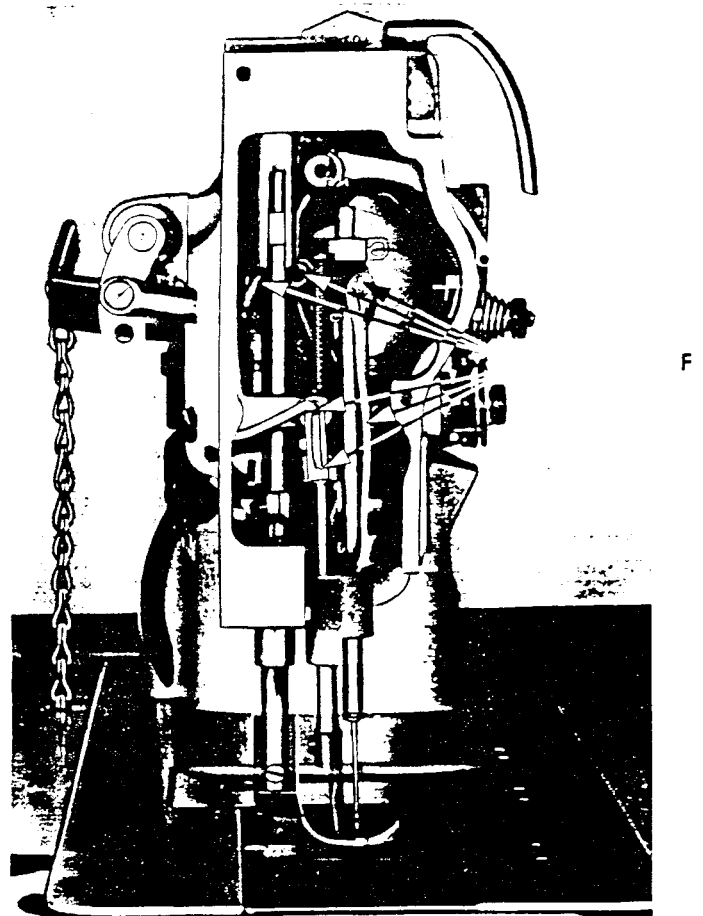

Figure 2

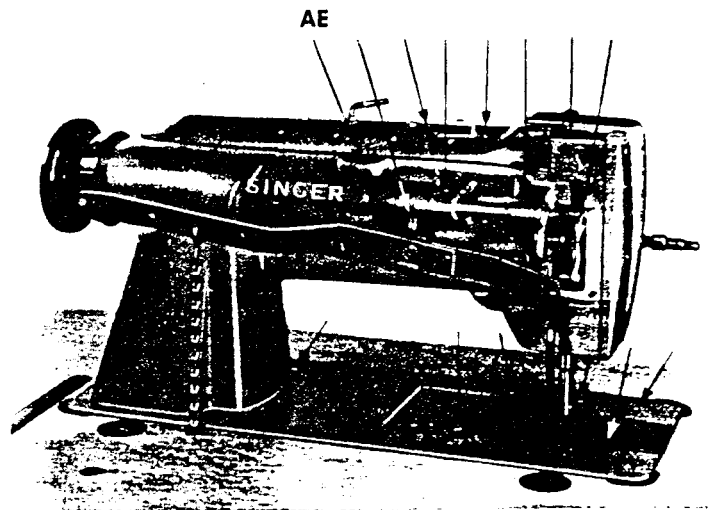

Figure 3

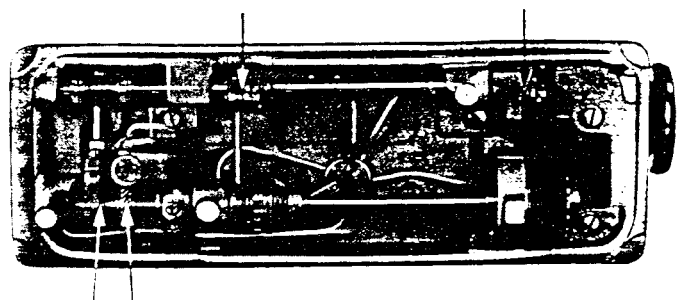

Figure 4

Figure 4 shows the underside of the 211 G 155 MACHINE and Fig. 5 that of the 211 G 155 MACHINE with the lubrication points for both machines. They can be oiled when the machine is tilted back on its hinges.

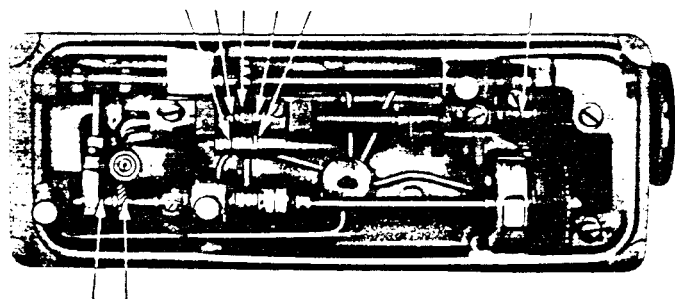

Figure 5

Figure 6 shows the hook lubrication points "G" and "H" which can be reached after opening the right hand bed slide. The oil reservoir "G" oils the upper hook bearing and the mechanism for the mechanical opener. The small green felt "H" on the bobbin case oils the



Figure 6

hook raceway and should always be saturated with oil. If the felt appears almost black, then there is sufficient oil. If it is dry, then the color is a light green. **On a new machine, the felt should be oiled each time the bobbin is changed.**

## NEEDLES

Original Singer Needles, Catalog No. 3355 (135x17) which are available in sizes 9 – 26 should be used for this machine. The needle size is determined by the size of the thread, which should run freely through the needle eye. Rough and non-uniform thread that does not run freely through the eye interferes with the proper function of the machine. Orders for needles should include the desired quantity, the catalog number, the size, and the type. The type is shown with a suffix:

1 – chrome plated, 2 – nickel plated, 3 – special fine point.

Example: 100 – 3355 – 12 – 1  
(100 needles – Catalog No. 3355 – Size 12 – Chrome Plated)

Needles and package carry the name: SINGER.

## THREAD (Figure 7)

Left-twist thread should be used in the needle. Either right or left twist can be used in the bobbin.

To determine the thread twist, hold the thread as shown in Figure 7. Turn it between thumb and forefinger of the right hand counter-clockwise (towards you). If left twist, the strands will wind tighter; if right twist, the strands will unwind.

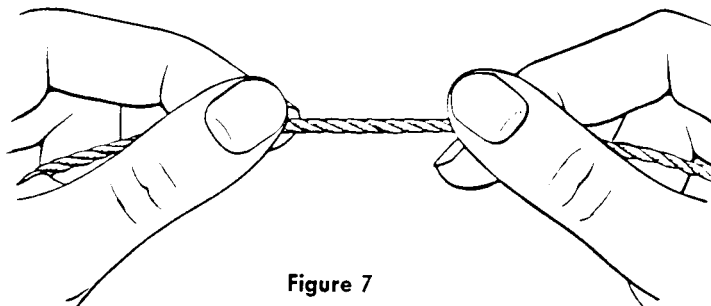

Figure 7

Based on past experience, the following needle sizes are recommended for the different threads.

Cotton Thread	Silk	Needle Size
100 to 150	000 to 00	10
90 to 100	00	11
80 to 90	0	12
70 to 80	A	13
60 to 70	A	14
50 to 60	B	15
40 to 50	C	16
30 to 40	C	18
24 to 30	D	20
16 to 24	E	22

## BOBBIN REMOVAL (Figure 8)

Turn the machine pulley towards you until the needle bar has reached its highest point. After opening the right bed slide, lift up latch "J", Fig. 8, and remove bobbin.

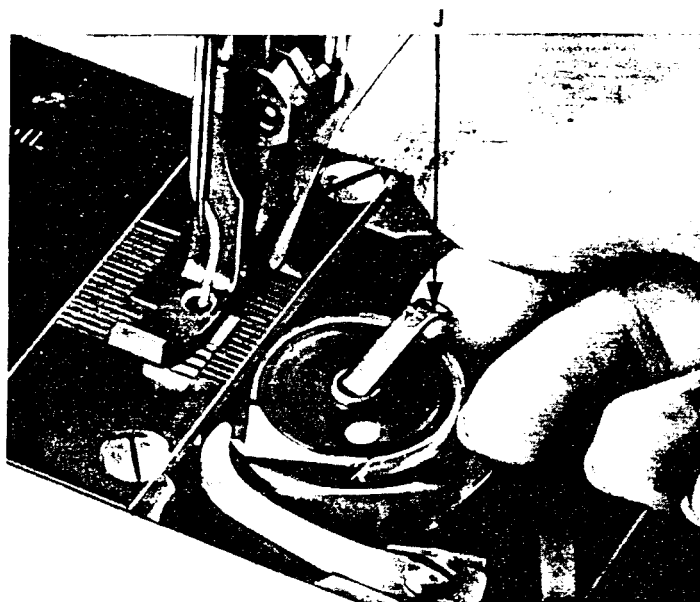

Figure 8

## TO WIND THE BOBBIN (Figure 9)

Place the bobbin onto the bobbin winder spindle sliding it on the spindle to its stop. Pass the thread through the thread guide "K", Fig. 9, in the tension control bracket and between the tension discs to the bobbin. Thread a few windings on the bobbin. Press down lever "E" to push the bobbin winder pulley against the drive belt and start the machine. When enough thread has been wound on the bobbin, the winder will stop automatically.

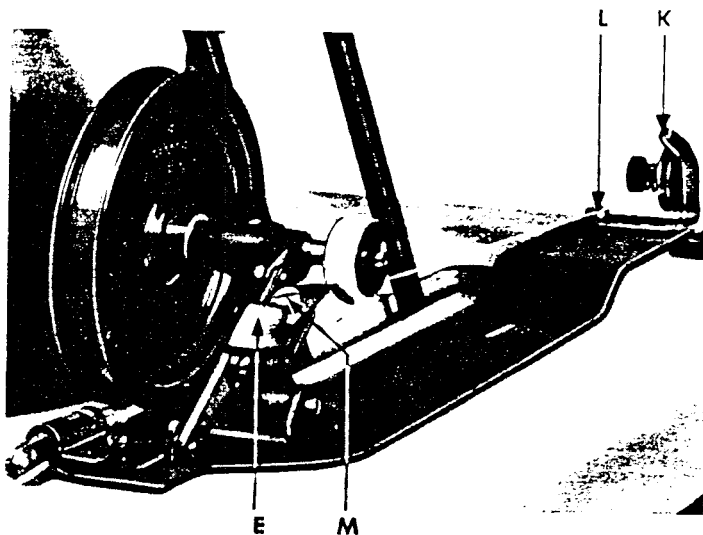

Figure 9

If the thread does not wind evenly, loosen screw "L", Fig. 9, and correct by moving the tension control bracket. Tighten screw "L". The amount of thread wound on the bobbin is adjusted with screw "M". For more thread, the screw is turned clockwise; for less thread, counter-clockwise. Bobbins can be wound while the machine is sewing.

## BOBBIN REPLACEMENT (Figures 10 and 11)

Hold the bobbin between thumb and forefinger of the right hand so that the thread unwinds at the bottom from left to right, Figure 10. Put bobbin onto the center stud and close latch "J", Figure 11. Pull the thread into



Figure 10

slot "N" and draw underneath the back of projection "O" on the bobbin case. Draw the thread through until it extends approximately 2 inches = 5 cm out of the

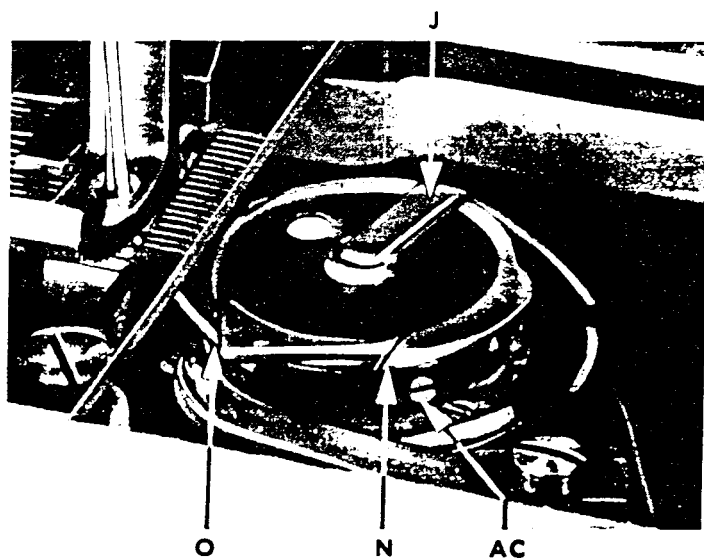

Figure 11

bed slide opening. The bed slide should not be closed completely to allow the thread to be pulled down.

## TO SET THE NEEDLE

Turn the machine pulley towards you until the needle bar has reached its highest position. Loosen set screw at the lower end of the needle bar and push the needle to its stop. The long groove should be on the left and the needle eye should be in line with the arm of the machine. Tighten the set screw thoroughly.

## THREADING OF NEEDLE THREAD (Figure 12)

With the needle at the highest position, pass the thread from the unwinder through the hole in the

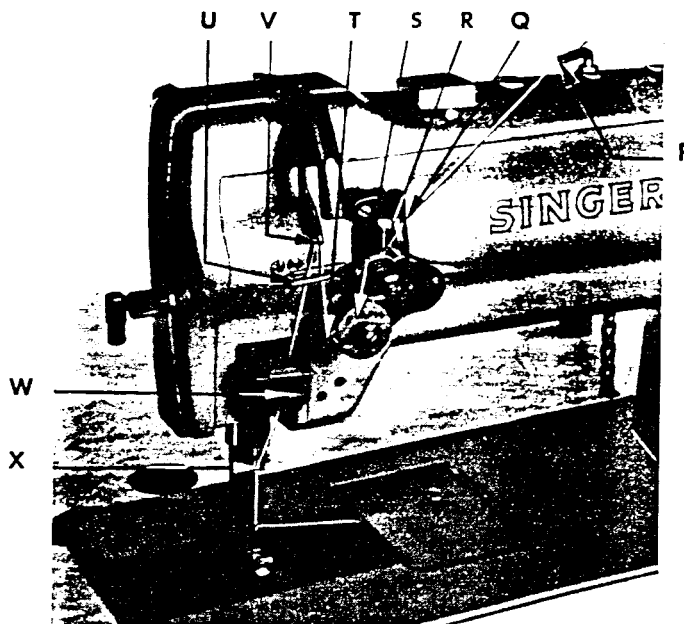

Figure 12

thread guide "P", Fig. 12, which is mounted on the arm cover. From there, pass the thread through the three (3) holes of the thread tensioner guide "Q". Starting with the top hole, thread from right to left, from left to right through the middle hole, and from right to left through the bottom hole. Pass the thread over and between the tension discs "R", from right to left, and wind it under and around thread controller "S" from right to left. It is placed under the controller spring "T" and over the controller projection so that the controller spring holds the thread down. Pull the thread through the thread guide "U" and then from right to left through the eye of the thread take-up "V". Pass it back again through the thread guide "U", lead it behind the oil felt pad "W" and then draw the thread through the thread guide "X", and from left to right through the eye of the needle.

## PREPARATION FOR SEWING

Hold the end of the needle thread loose in the left hand. Turn the machine pulley towards you until the needle has made one full stitch and is back to its highest point. By pulling the needle thread, the bobbin thread will come through the hole in the feed dog. Lay both threads underneath the presser feet and close the bed slide completely. Now the machine is ready for having the material placed under the presser feet.

## ADJUSTMENT OF THREAD LUBRICATION

(Figure 13)

The oil reservoir for thread lubrication can be filled through hole "Y", Fig. 13, in the face plate. The amount of oil going to the oil felt pad can be adjusted by nut "Z"; for more oil, turn counter-clockwise; for less oil,

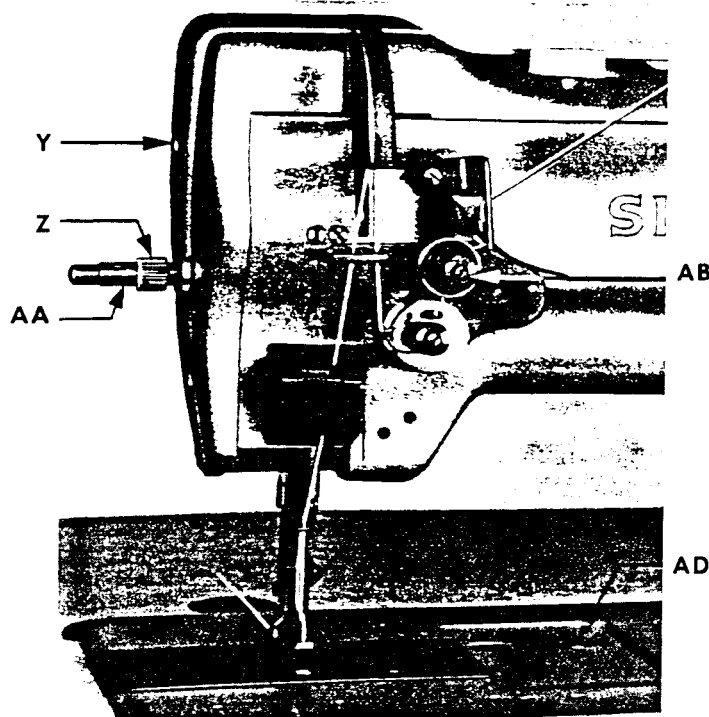

Figure 13

turn clockwise. The oil flow can be turned on and off with the plunger release lever "AA". The oil flows when the lever is in the horizontal position; there is no flow when it is in the vertical position.

For thread lubrication always use Singer Thread Lubricant, Type "E".

## TENSION CONTROL

(Figures 11, 13, 14, 15 and 16)

The tension of the needle thread is regulated by thumb nut "AB", Fig. 13, and should only be changed when the presser feet are down and the tension is not released. Turning the nut clockwise increases and turning it counter-clockwise decreases the tension.

The tension of the bobbin thread is regulated on the bobbin case tension spring by means of the adjusting screw "AC", Fig. 11. Turning it clockwise increases and turning it counter-clockwise decreases the tension.



Figure 14

With correctly adjusted tensions, the needle and bobbin threads should be locked in the center of the material as shown in Figure 14.

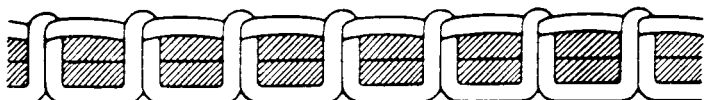

Figure 15

If the tension on the needle thread is too tight, or if that on the bobbin thread is too loose, the needle thread will lie straight along the upper surface of the material as shown in Figure 15.



Figure 16

If the tension on the bobbin thread is too tight, or if that on the needle thread is too loose, the bobbin thread will lie straight along the underside of the material as shown in Figure 16.

## ADJUSTMENT OF STITCH LENGTH (Figure 13)

The stitch length can be adjusted only when the machine is stopped. Stitch length, in number of stitches per inch, can be read on the stitch length indicator of the machine pulley. To change the stitch length, depress the button "AD", Fig. 13, and turn the machine pulley until the button engages (clicks) with the adjustable feed drive eccentric. Continue turning until the desired number of stitches per inch appears opposite the mark on the machine arm. Then release the button.



---

## REGULATION OF PRESSER FOOT PRESSURE (Figure 3)

---

The pressure on the material should be as light as possible while still sufficient to insure correct feeding.

The presser foot pressure is adjusted with screw "AE", Fig. 3. Turning of the screw clockwise increases and counter-clockwise decreases the pressure.

---

## REENGAGEMENT OF SAFETY CLUTCH (Figure 13)

---

A safety clutch to prevent any overload and damage to the hook is installed in the lower belt pulley. If it is disengaged, open the bed slide and check the hook. Remove all thread and foreign matter from the hook by carefully turning the machine pulley forward and backward until the machine turns freely. By pressing the

stitch length regulator button "AD", Fig. 13, and at the same time turning the machine pulley, the hook driving shaft is locked until the safety clutch is reengaged. Reset the stitch length and the machine is ready for sewing.

---

## TO USE THE REVERSE FEED ON THE 211 G 156 MACHINE (Figures 20 and 26)

---

The feed of the machine can be reversed by hand lever or foot treadle.

To change feed direction by hand, push the reverse lever "AF", Fig. 20, completely down in order to have the same stitch length as in forward feed.

Release it only when you want to again feed the material in the normal direction.

To reverse the feed with the foot treadle, the foot treadle chain should be connected to the hole in the reversing lever "AG", Fig. 26.

## TIMING AND OTHER ADJUSTMENTS

The instructions on the following pages are for Adjusters and Mechanics only.

---

## ADJUSTMENT OF THE THREAD CONTROLLER SPRING (Figure 17)

---

The function of the thread controller spring is to hold back the slack of the needle thread until the point of the needle reaches the material on its upward stroke,

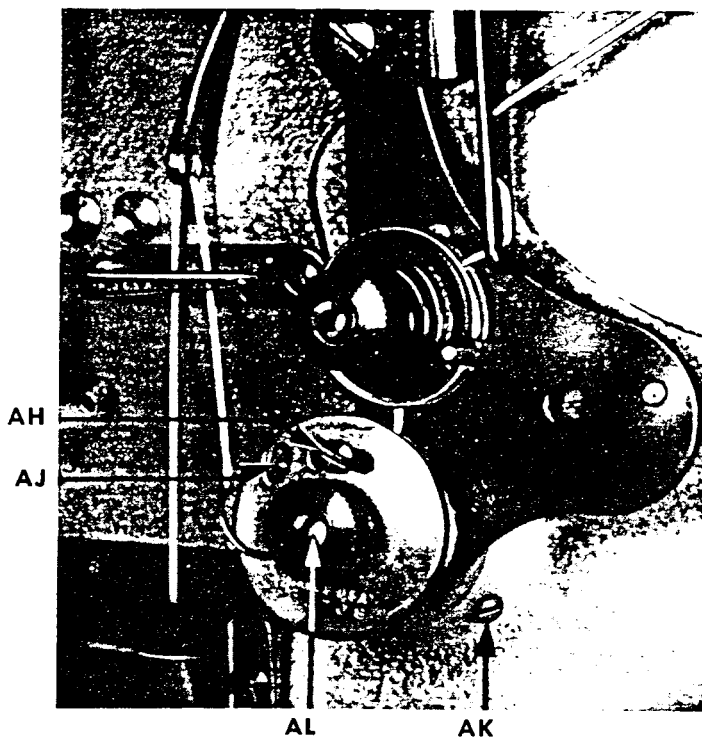

Figure 17

as without this controlling action of the spring, the slack thread (especially silk) will sometimes be penetrated by

the point of the needle as the needle is descending. The spring should be adjusted so that the thread is under a light tension when it passes around the bottom of the bobbin case and is cast off the hook point. The tension of the controller spring should be sufficiently heavy to work satisfactorily at high speed and should also be light enough to allow the full upward movement of the spring before thread is demanded by the take-up. The regulation of the controller spring depends on sewing condition and the thread used.

Adjust the spring travel by loosening screw "AH", Fig. 17, and turning spring stop "AJ".

To adjust the spring tension, loosen set screw "AK", Fig. 17, and turn tension stud "AL". Turning counter-clockwise increases and turning clockwise decreases the tension.

---

## ADJUSTMENT OF TENSION RELEASE (Figure 24)

---

The tension release automatically relieves the spring pressure exerted on the needle thread tension disc when the presser feet are moved to the top position by the hand or knee lifter. The release can be adjusted by loosening screws "AM", Fig. 24, and positioning tension release spring. Then securely tighten screws "AM".

---

## ADJUSTMENT OF NEEDLE BAR ROCK FRAME (Figures 18, 19, 20 and 21)

---

On the 211 G 155 MACHINE the needle bar rock frame is driven by a compound drive mechanism which

can be made synchronous or differentiated with the lower feed. It must be adjusted so that, in zero position of the synchronous feed, the distance between the vibrating presser bar in the needle bar rock frame and the vertically moving presser bar, in the arm, is  $2\frac{1}{64}$  inch = 8,33 mm (see Figure 21).

AQ AO AN AP

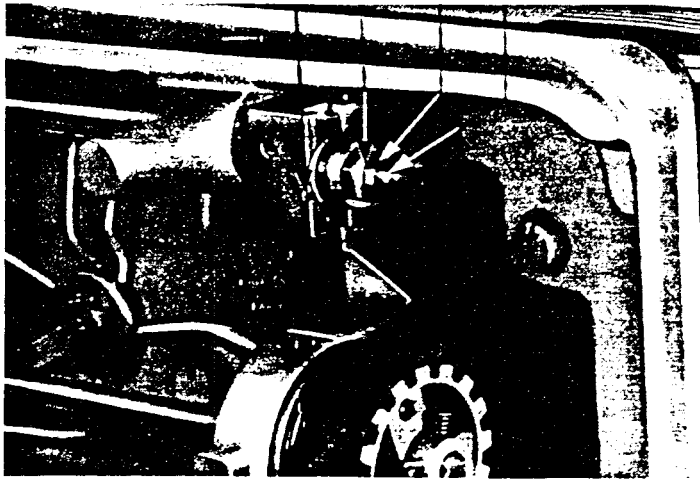

Figure 18

For synchronous feed, and for alignment of the needle bar rock frame, adjust the feed driving eccentric for zero stitches. Loosen lock nut "AN", Fig. 18, and bearing nut "AO". Then move screw "AP", Fig. 18, to its normal operating position against an inserted  $\frac{5}{64}$  inch = 2 mm diameter pin or needle shank in the slot of the adjustable crank "AQ". Remove the front arm cover, loosen screw "AR", Fig. 19, and adjust the needle bar rock frame to the vertically moving presser

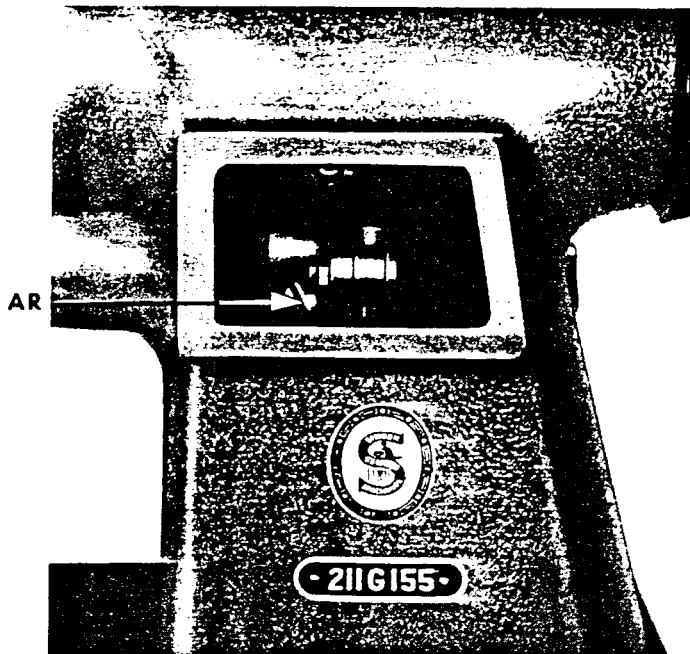

Figure 19

bar to obtain the distance between the vibrating presser bar and the vertically moving presser bar as shown in Figure 21.

For differentiated feed, adjust the feed driving eccentric to the desired number of stitches per inch. Loosen

lock nut "AN" and bearing nut "AO". Move screw "AP" in the adjustable crank to the back in order to get a larger movement of the upper feed relative to the lower feed, and to the front for a smaller movement.

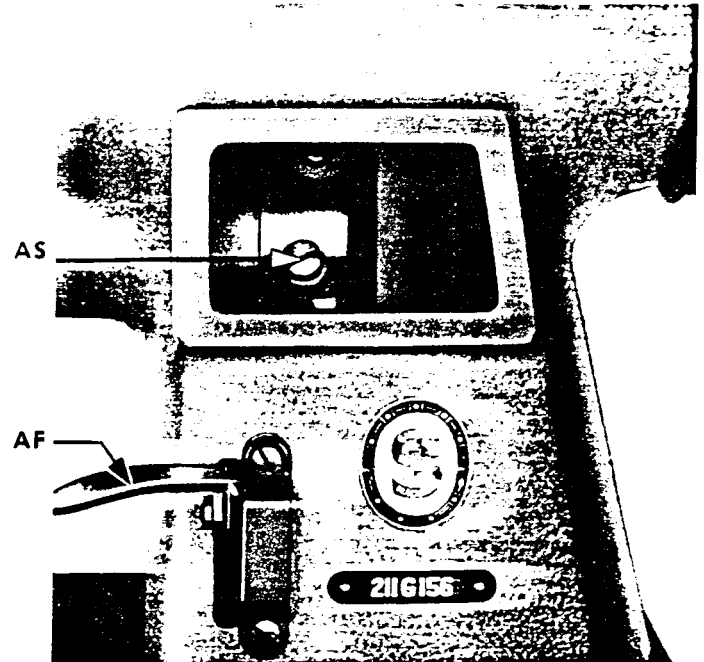

Figure 20

On the 211 G 156 MACHINE the needle bar rock frame is driven synchronously with the lower feed. It has to be adjusted so that, in zero position, the distance between the vibrating presser bar in the needle bar rock frame and the vertically moving presser bar, in the arm, is  $1\frac{9}{64}$  inch = 7,54 mm (see Figure 21).

For alignment of the needle bar rock frame, adjust the feed driving eccentric for zero stitches, so that it cannot feed. Remove the front arm cover, loosen screw "AS", Fig. 20, and adjust the needle bar rock frame to the vertically moving presser bar to obtain the distance between the vibrating presser bar and the vertically moving presser bar as shown in Figure 21.

## ADJUSTMENT OF HEIGHT OF NEEDLE BAR (Figure 21)

The adjustment of the needle bar height can be checked with two timing marks which are located approximately 2 inches = 50,8 mm from the lower end of the bar. The upper mark should be just visible at the lower edge of the needle bar rock frame when the needle bar is in its lowest position. The lower mark should be just visible when the hook point has reached the center line of the needle with the feeding mechanism in zero position (synchronous on the 211 G 155 MACHINE).

The needle bar can be adjusted up or down by loosening the pinch screw "AT", Fig. 21, accessible through a hole in the face plate. This hole eliminates the necessity of removing the face plate to make the adjustment. Securely tighten screw.

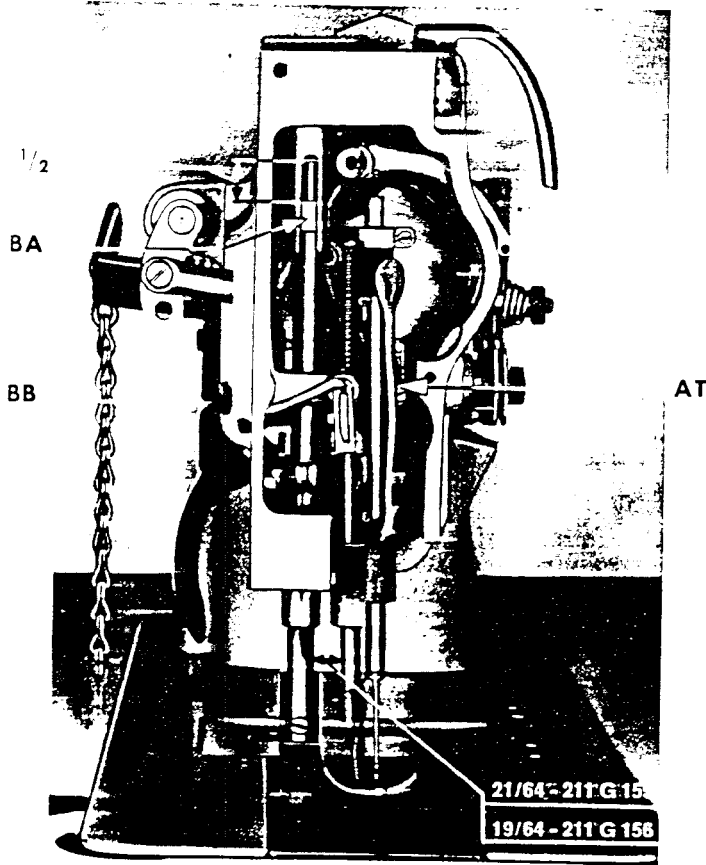

Figure 21

To set a needle bar which has no timing marks, the feeding mechanism must be set on zero stitches (synchronous on the 211 G 155 MACHINE). Insert a straight needle in the needle bar so that, when it rises  $\frac{3}{32}$  inch = 2,4 mm from its lowest position, the point of the hook is at center line of the needle and the eye of the needle about  $\frac{1}{16}$  inch = 1,6 mm below the point of the hook.

### ADJUSTMENT OF THE HOOK (Figures 22 and 23)

To adjust the hook relative to the needle (distance and timing) remove the throat plate and set the feeding mechanism on zero stitches (synchronous on the 211 G 155 MACHINE). Check the needle bar height for proper adjustment and use a straight needle which has been correctly inserted to its stop. Turn the machine pulley over towards you until the lower mark on the needle bar is just visible at the end of the needle bar rock frame on the upward stroke of the needle bar. In this position the hook point should be about  $\frac{1}{16}$  inch = 1,6 mm above the needle eye on the center line of the needle and as close as possible to it without touching. The needle should barely touch the hook needle guard "AW", Fig. 23, without being deflected by it.

To adjust the distance between hook point and needle, maintain the hook point at the center of the needle, loosen screws "AU", Fig. 22, underneath the bed of the machine, and move the hook saddle to the right or left as required. Then securely tighten screws "AU".

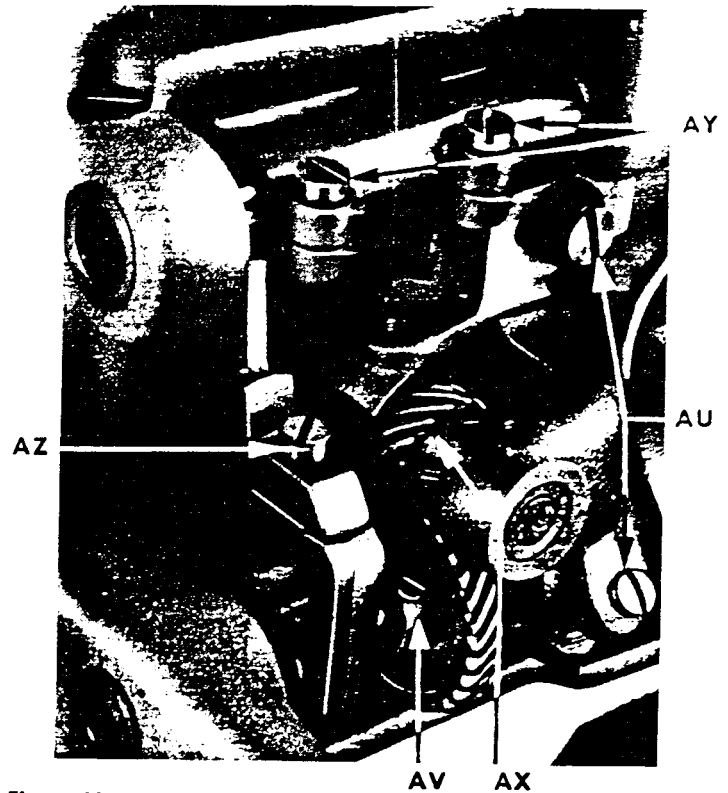

Figure 22

To time the hook point relative to the center line of the needle, loosen the set screws on the hub of the hook driving gear "AV", Fig. 22. Then tap the gear to the

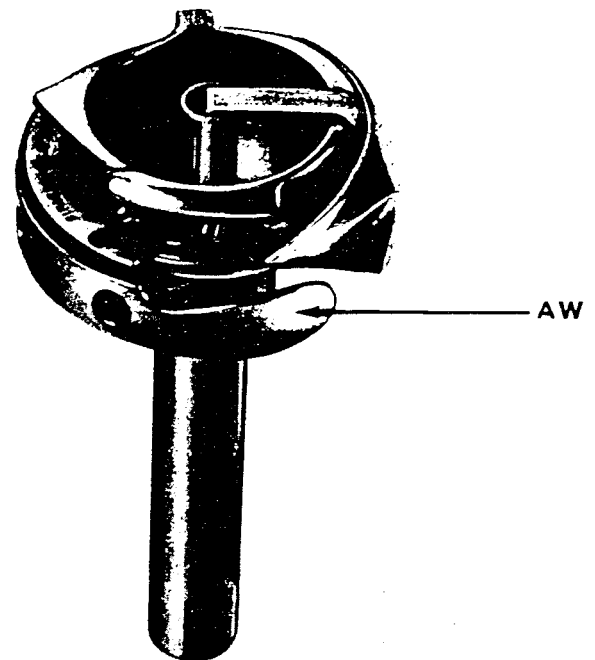

Figure 23

right, if the hook time is to be advanced, and to the left if it is to be retarded.

The hook needle guard "AW", Fig. 23, which is mounted on the outer periphery of the hook, should be adjusted so that the needle can never touch the hook point in the event that it is deflected in that direction.

---

## REPLACEMENT OF HOOK (Figure 22)

---

To replace the hook, remove the presser feet, throat plate, bed slide, feed dog, and the bobbin case opener. Loosen the set screws in the hub of the hook drive gear "AX", Fig. 22, pull the hook upwards from the hook saddle, and insert a new one. Then replace the feed dog and the bobbin case opener. The new hook should be adjusted as explained above.

---

## FEED DOG ADJUSTMENT (Figure 22)

---

The feed dog is attached by two screws to the feed bar. The feed dog should be adjusted sideways in the throat plate so that it does not touch it. It should also be centered in the direction of feeding so that the needle, in its lowest position, will be slightly in front of the center of the needle hole (seen from the front). For average sewing conditions, a full tooth of the feed dog should show above the throat plate with the feed dog in its highest position.

The feed dog can be adjusted with respect to the throat plate and needle by loosening the two pinch screws "AY", Fig. 22. Securely tighten pinch screws "AY".

To adjust the feed dog height, turn the machine pulley towards you until the feed dog is at its highest position. Loosen screw "AZ", Fig. 22, and pinch screws "AY", Fig. 22. Then move the feed bar to raise or lower the feed dog as required. Securely tighten screws "AZ" and "AY".

When raising or lowering the feed dog, care must be taken that its underside does not drop low enough to strike the hook.

---

## ADJUSTMENT OF THE PRESSER BAR HEIGHT (Figure 21)

---

In order to prevent damage to the alternating mechanism, the clearance under the presser feet is limited to  $\frac{1}{2}$  inch = 12,70 mm by the guide block "BA", Fig. 21, in the presser bar guide. The presser bar releasing lever bracket "BB", that is part of the alternating mechanism, must be adjusted so that there is a  $\frac{1}{64}$  inch = 0,4 mm clearance between the hand presser bar lifter and the releasing lever bracket "BB" when both presser feet are resting on the throat plate. This adjustment can be accomplished by loosening the pinch screws and moving the guide block "BA" or the releasing lever bracket "BB". Securely tighten the pinch screws.

---

## ADJUSTMENT OF THE LIFTING ECCENTRIC AND THE LIFT OF THE ALTERNATING PRESSER FEET (Figure 24)

---

The lift of the alternating presser feet is governed by the thickness of the material sewn, and should be no

higher than necessary. Normally, the lift is the same for both presser feet and is infinitely variable within the machine's capability by means of the lifting adjustable eccentric.

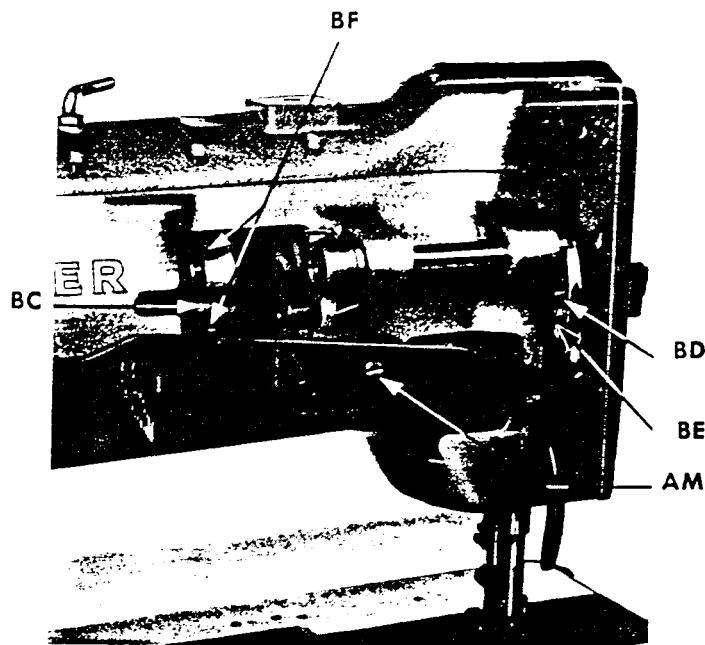

Figure 24

To adjust the lift of the presser feet use a screw driver to hold the lifting eccentric adjusting disc "BC", Fig. 24, from turning. To increase the lift, turn the machine pulley towards the operator; to decrease, turn the machine pulley away from the operator. For special requirements, the lift height can be increased by moving the screw stud "BD" to the threaded hole "BE", Fig. 24.

To time the lift of the alternating presser feet, loosen the set screws "BF", Fig. 24, in the lifting eccentric and adjust the eccentric on the arm shaft. For normal work, the lifting eccentric is regulated with the presser feet at the same height, so that the point of the needle enters the throat plate when the feed dog touches the movable presser foot while both are even with the upper edge of the throat plate. Securely tighten the set screws "BF".

---

## ADJUSTMENT OF THE FEED DRIVING ECCENTRIC (Figures 25 and 26)

---

The stitch length of the machine can be adjusted by means of the feed driving eccentric as explained under "ADJUSTMENT OF STITCH LENGTH". The feed driving eccentric is mounted on the bed shaft as illustrated in Figure 25 for the 211 G 155 MACHINE and in Figure 26 for the 211 G 156 MACHINE.

The feed driving eccentric "BG" is held in a guide of the feed driving flange "BH" and adjusted by means of the adjusting screws "BJ" which are secured by lock screws to prevent shifting. To adjust, loosen the two lock screws and turn in the two adjusting screws "BJ" until all play is eliminated and the eccentric fits quite snugly in the guide of the feed driving flange "BH".

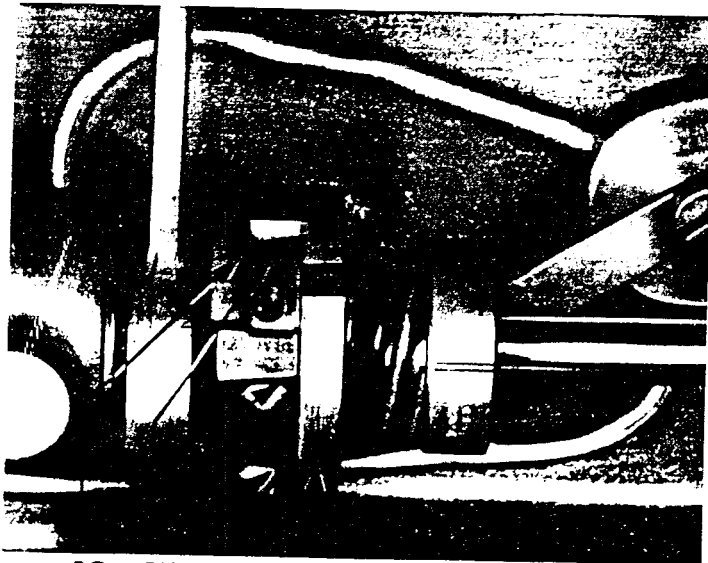

BG BH BJ BK  
Figure 25

The linear movement of the eccentric is accomplished by turning the adjusting disc "BK". A spring located between the adjusting disc and a collar prevents the disc from moving out of position when the machine is in operation.

The timing of the eccentric in relation to the needle movement is achieved by the feed driving eccentric positioning screw in a splined groove of the bed. The positioning screw is the first screw to appear when turning the machine pulley in normal direction of rotation.

### ADJUSTMENT OF THE REVERSE FEEDING MECHANISM ON THE 211 G 156 MACHINE (Figure 26)

As explained under "TO USE THE REVERSE FEED ON THE 211 G 156 MACHINE", the direction of feed

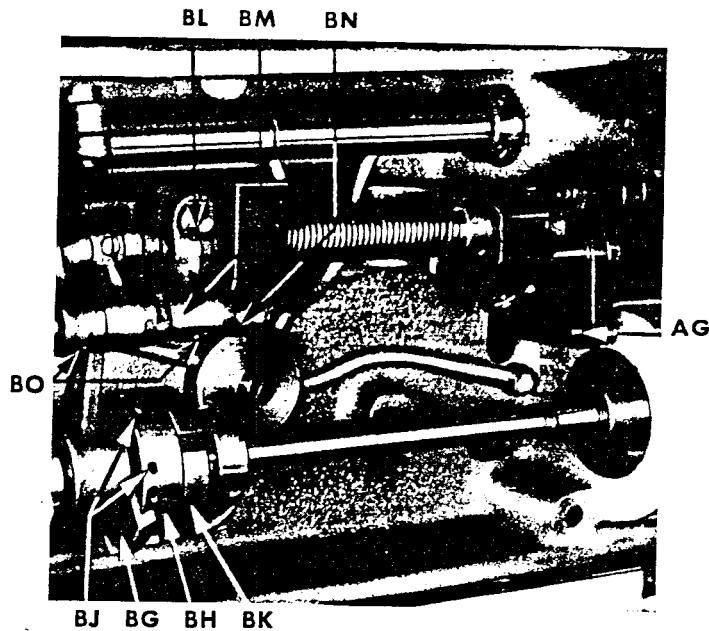

BL BM BN  
BO AG BJ BG BH BK  
Figure 26

can be reversed by using the reverse feeding mechanism which is adjusted at the factory for equal stitch length for forward and reverse sewing. Its bearing block is pinned in position and should never be changed.

To adjust this mechanism, set the feed driving eccentric "BG", Fig. 26, to 5 stitches/inch, loosen screws "BL", Fig. 26, and move crank "BM", Fig. 26 until 5 needle penetrations make exactly one inch. Then fully depress the reversing lever and the eccentric head of the bearing pin "BN", Fig. 26, should be resting against the bearing block. Loosen the two set screws "BO", Fig. 26, and turn the bearing pin "BN" until the stitch length is the same in advance and reverse. Securely tighten all screws.

### REPLACEMENT OF ARM SHAFT CONNECTION BELT (Figure 27)

Remove the needle to avoid damage to the hook. Slide belt off the lower pulley, loosen the two screws in the machine pulley, and remove the machine pulley with the ball bearing from the arm shaft. Lift the belt up and draw it around the arm shaft through the space normally occupied by the ball bearing.

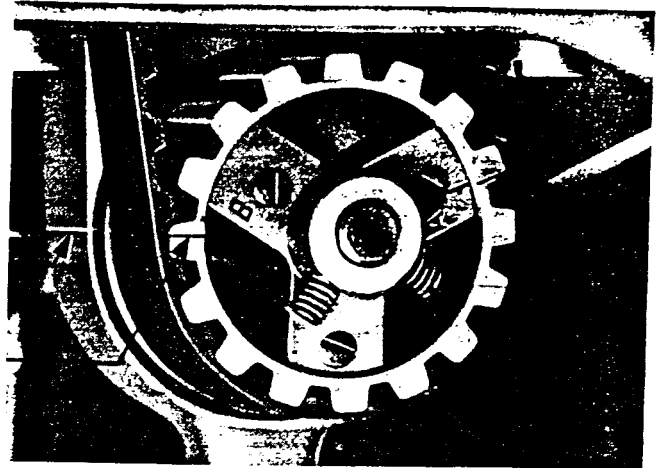

BQ BP  
Figure 27

The new belt is inserted through the ball bearing hole. After placing belt over upper pulley, replace machine pulley. To remove all end play from the shaft, lightly tighten set screws in machine pulley and (holding needle bar crank in place) tap the machine pulley into position with the palm of the hand. Tighten the machine pulley set screws firmly.

Turn the machine pulley over toward you until the thread take-up lever is at its highest point. Then turn the hook driving shaft until the setting mark "B" on the safety clutch pulley "BP", Fig. 27, is in line with mark "BQ", Fig. 27, cut into the machine bed. Now, without disturbing the timing of either the arm shaft or the hook driving shaft, slip belt over lower pulley.

After the needle has been reinserted, the relationship of needle to hook should be checked. The hook point should be on the center line of the needle and 1/16 inch above the needle eye.

# The Same!

---

To get replacements  
that are the same  
as parts in new  
machines...

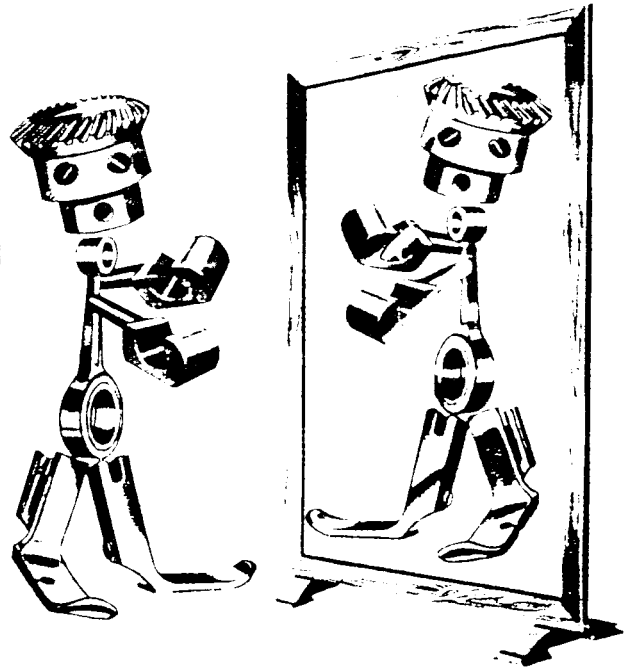

## BUY PARTS AND NEEDLES MADE BY **SINGER**

TO BE DOUBLY SURE...

of new machine performance, make sure that all  
replacement parts and needles are identical to those  
in new SINGER machines.

Look for the trademark

## SINGER

- ① on every package or container
- ② on the needle or numbered part

Needles in containers marked "For Singer Machines" are NOT made by SINGER.

### TO ALL WHOM IT MAY CONCERN:

The improper placing or renewal of the Trademark "SINGER" or any other of the Trademarks of The Singer Company (all of which are duly Registered Trademarks) on any machine that has been repaired, rebuilt, reconditioned, or altered in any way whatsoever outside a SINGER factory or an authorized SINGER agency is forbidden.