

SINGER
451K125

USE ONLY **SINGER** OILS and LUBRICANTS

THEY INSURE FREEDOM FROM LUBRICATING TROUBLE AND GIVE
LONGER LIFE TO SEWING EQUIPMENT

The following are the correct lubricants for the
451K Machines

TYPE A—MANUFACTURING MACHINE OIL, LIGHT GRADE

When a stainless oil is desired, use :

TYPE C—MANUFACTURING MACHINE OIL, LIGHT GRADE

OTHER **SINGER** LUBRICANTS

TYPE E—THREAD LUBRICANT

For lubricating the needle thread of sewing machines for
stitching fabrics or leather where a thread lubricant is
required.

TYPE F—MOTOR OIL

For oil lubricated motors and plain bearings in power
tables and transmitters.

NOTE: The above oils are available in 1 quart, 1 gallon
and 5 gallon tins or in 40 gallon drums.

BALL BEARING LUBRICANT

This pure grease is specially designed for the lubrication
of ball bearings and ball thrust bearings of motors and
electric transmitters, ball bearing hangers of power tables,
etc. **Furnished in 1 lb. and 4 lb. tins.**

SERVICE MANUAL FOR **SINGER**^{*} SEWING MACHINE 451K125

HIGH SPEED LOCK STITCH

Single Rotary Thread Take-up

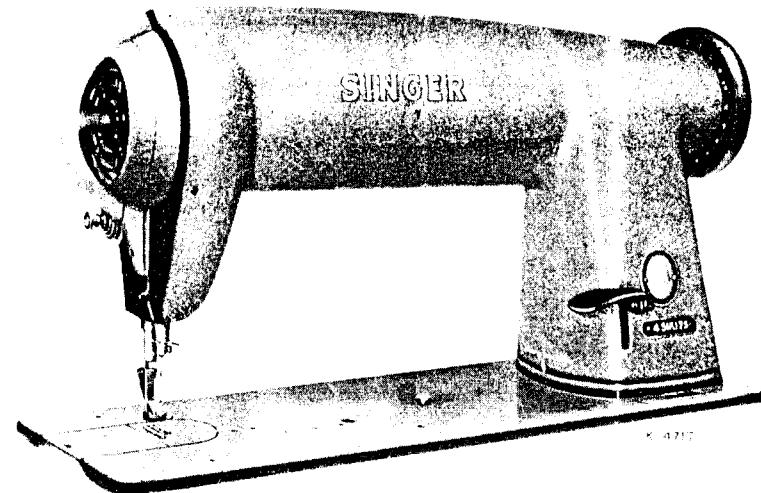

Special attention is called to the lubricating instructions
on pages 4 and 5.

*A TRADE MARK OF

THE SINGER MANUFACTURING COMPANY

TO ALL WHOM IT MAY CONCERN :

3

The improper placing or renewal of the Trade Mark "SINGER" or any other of the Trade Marks of The Singer Manufacturing Company (all of which are duly Registered Trade Marks) on any machine that has been repaired, rebuilt, reconditioned, or altered in any way whatsoever outside a SINGER factory or an authorised SINGER agency is forbidden.

THE IMPORTANCE OF
USING **SINGER** PARTS AND NEEDLES
IN **SINGER** MACHINES

The successful operation of SINGER machines can only be assured if SINGER parts and needles are used. Supplies are available at all SINGER Shops for the Manufacturing Trade, and mail orders will receive prompt attention.

SINGER Needles should be used
in SINGER Machines.
These Needles and their Containers
are marked with the
Company's Trade Mark SIMANCO.* 1

Needles in Containers marked
"FOR SINGER MACHINES"
are NOT SINGER made needles. 2

DESCRIPTION

Machine 451K125, for stitching light, medium and medium-heavy weight fabrics, has the following characteristics :

Single Needle, Lock Stitch.

Single Rotary Thread Take-up.

Pendant Link Feeding Mechanism which produces a uniform stitch length at all speeds.

Belt Driven, Automatically Lubricated Rotary Sewing Hook on a Horizontal Axis.

Drop Feed.

Hand operated reversible feed with spring return to forward stitch.

Knee Lifter.

Maximum Length of Stitch six to the inch forward and seven to the inch reverse.

Presser Bar Lift 5/16 inch.

Needle Bar Stroke 1-5/16 inches.

Machine Pulley with outside diameter of belt groove 2.90 inches for 3/8 inch "V" belt. Effective diameter for 5/16 inch round leather belt is 2-3/8 inches. The top of the machine pulley turns over from the operator.

Ball Bearings for both ends of arm shaft and pulley end of hook driving shaft.

Needle Bearings for Needle Bar Connecting Link and Feed Driving and Lifting Connections.

Bed 18-3/4 inches long, 7 inches wide.

Space at right of needle 11 inches.

SPEED

The maximum speed recommended is 5000 R.P.M. It is advisable to run a new machine slower than the maximum speed for the first few minutes to allow time for the oil to reach the moving parts.

SETTING UP

The drip pan should be attached with its right end even with the right end of the cut-out and low enough in the cut-out to avoid interference with the knee lifter rod A, Fig. 2. Fig. 2 shows the correct location of the knee lifter. The knee lifter bracket should be assembled so that the lifter rod A does not strike the drip pan. The screw slots in the bracket provide the necessary adjustment. The stop stud B, Fig. 2 should be set to stop the action of the knee lifter as soon as the presser foot is raised enough to trip the hand lifter.

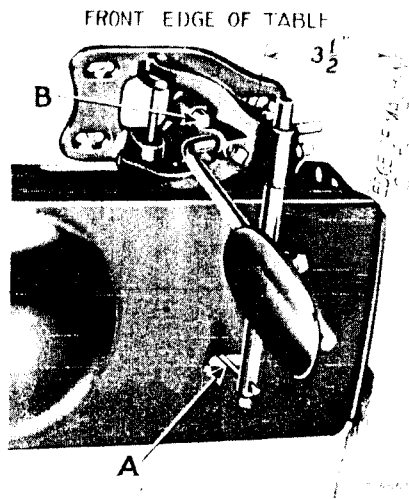

Fig. 2. Position of Knee Lifter Under Table

CAUTION : Do not start the machine, not even to test the speed, until it has been thoroughly oiled as instructed below and on page 5.

OILING THE MACHINE

Use "TYPE A" or "TYPE C" OIL, sold by Singer Sewing Machine Company. For description of oils, see inside of front cover.

A reservoir in the bed of the machine supplies oil to the sewing hook race and to the bearings and eccentrics on the hook driving shaft (except the rear ball bearing). The other lubrication points are reached by five oil holes, marked with red.

BEFORE STARTING THE MACHINE, fill the oil reservoir (through the oil gauge hole) to the top mark on the oil gauge C, Fig. 3.

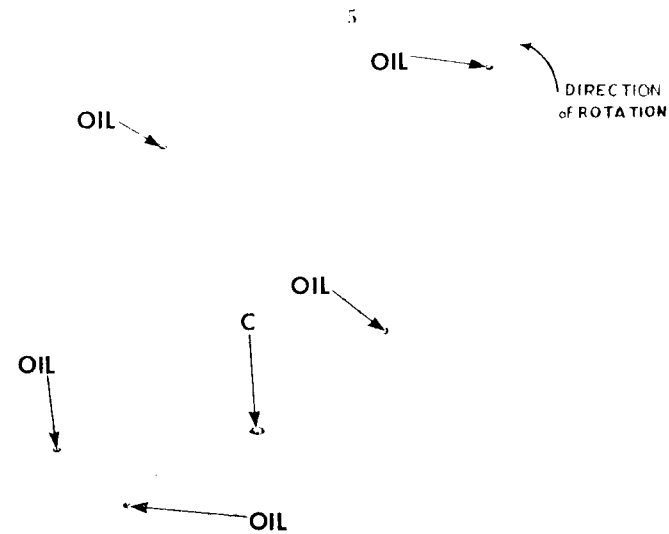

Fig. 3. Showing the Six Oiling Points on the Machine

While it may not be necessary to add oil to the reservoir every day, the oil level must be checked DAILY and filled to the high mark. Never allow the oil level to drop below the lower mark on the oil gauge.

AT THE BEGINNING OF EACH WORKING DAY, place A FEW DROPS of oil in each of the five oil holes indicated by the arrows in Fig. 3 as well as the oil hole in the bobbin winder spindle indicated in Fig. 6.

NEEDLES

Needles for Machine 451K125 are of Class and Variety 135x25 and are made in a variety of sizes. These needles regularly have nickel finish but can be supplied with chromium finish if so ordered.

The size of the needle to be used should be determined by the size of the thread, which must pass freely through the eye of the needle. Rough or uneven thread, or thread which passes with difficulty through the eye of the needle, will interfere with the successful use of the machine.

Orders for needles must specify the Quantity required, the Size number, also the Class and Variety numbers separated by an x.

The following is an example of an intelligible order :
"100 No. 16, 135x25 Needles."

The best stitching results will be obtained by using the needles sold by Singer Sewing Machine Company.

THREAD

Left twist thread should be used in the needle. Either right or left twist thread can be used in the bobbin.

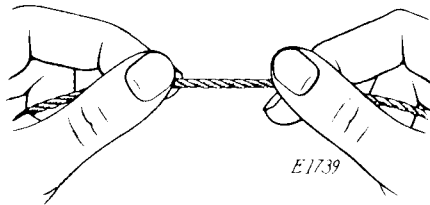

Fig. 4. How to Determine the Twist

Hold the thread as shown above. Turn the thread over toward you between the thumb and forefinger of the right hand; if left twist, the strands will wind tighter; if right twist, the strands will unwind.

TO REMOVE THE BOBBIN

Turn the machine pulley over from you until the needle moves up to its highest position. Draw back the slide in the bed of the machine. Reach under the table and open the bobbin case latch **E**, Fig. 5 and, by means of this latch, remove the bobbin case from the sewing hook.

While the latch remains open, the bobbin will be retained in the bobbin case. Release the latch, turn the open end of the bobbin case downward and the bobbin will drop out.

K 4746

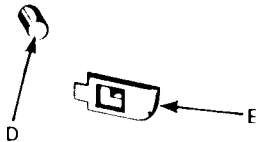

Fig. 5. Removing the Bobbin

TO WIND THE BOBBIN

Fasten the bobbin winder to the table with its driving pulley in front of the machine belt, so that the pulley will drop away from the belt when sufficient thread has been wound upon the bobbin.

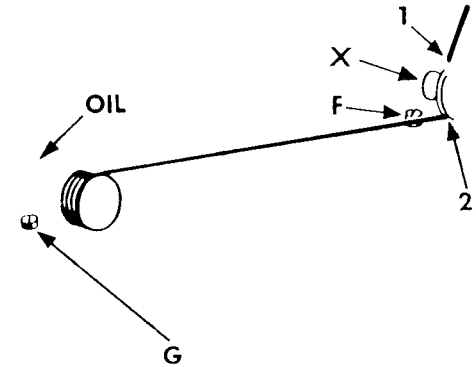

Fig. 6. Winding the Bobbin

Place the bobbin on the bobbin winder spindle and push it on as far as it will go.

Pass the thread down through the thread guide **1** in the tension bracket, around the back of, and between, the tension discs **2**. Then wind the end of the thread around the bobbin a few times in the direction shown in Fig. 6, push the bobbin winder pulley over against the machine belt and start the machine.

When sufficient thread has been wound upon the bobbin, the bobbin winder will stop automatically.

If the thread does not wind evenly on the bobbin, loosen the screw **F** in the tension bracket and move the bracket to the right or left as may be required, then tighten the screw.

The amount of thread wound on the bobbin is regulated by the screw **G**. To wind more thread on the bobbin, turn the screw **G** inwardly. To wind less thread on the bobbin, turn this screw outwardly.

Bobbins can be wound while the machine is stitching.

When winding a bobbin with fine thread, a light tension should be used. Adjust the knurled nut **X**, Fig. 6, to regulate the tension.

TO THREAD THE BOBBIN CASE

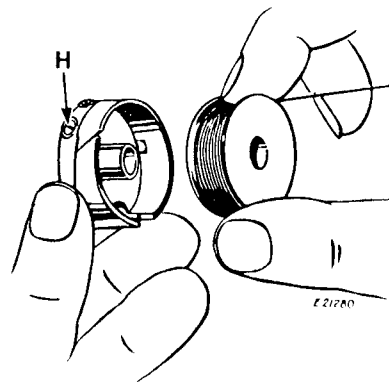

Fig. 7

Hold the bobbin between the forefinger of the right hand, as shown in Fig. 7, the thread drawing on the top from the left toward the right.

With the left hand hold the bobbin case as shown in Fig. 7, the slot in the edge being near the top, and place the bobbin into it.

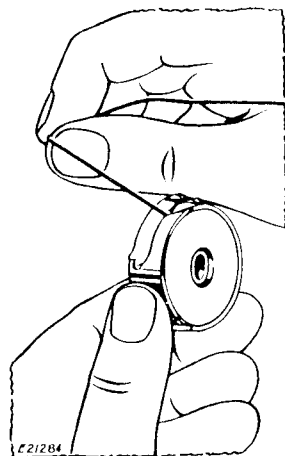

Fig. 8

Then pull the thread into the slot in the edge of the bobbin case as shown in Fig. 8; draw the thread under the tension spring and into the delivery eye at the end of the tension spring. See Fig. 9.

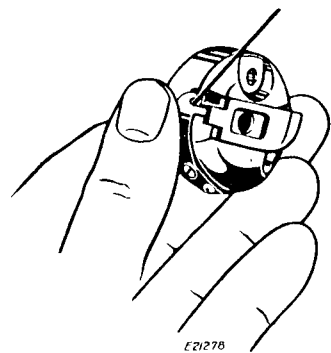

Fig. 9

TO REPLACE THE BOBBIN CASE

After threading, take the bobbin case by the latch and place the bobbin case on the centre stud **D**, Fig. 5 of the bobbin case holder; release the latch and press the bobbin case back until the latch catches the groove near

K 4 747



Fig. 10. Bobbin Case Threaded and Replaced

the end of the stud. See Fig. 10. Allow about two inches of thread to hang free, and replace the slide in the bed of the machine.

TO SET THE NEEDLE

Turn the machine pulley over from you until the needle bar moves up to its highest point; loosen the screw at the lower end of the needle bar and put the needle up into the bar or clamp as far as it will go, with the long groove of the needle toward the left and the eye of the needle directly in line with the arm of the machine, then tighten the screw.

UPPER THREADING

See Fig. 11

When you have become accustomed to threading the machine, the thread can be passed from the thread retainer **J** at the top, down to the needle with a single continuous motion.

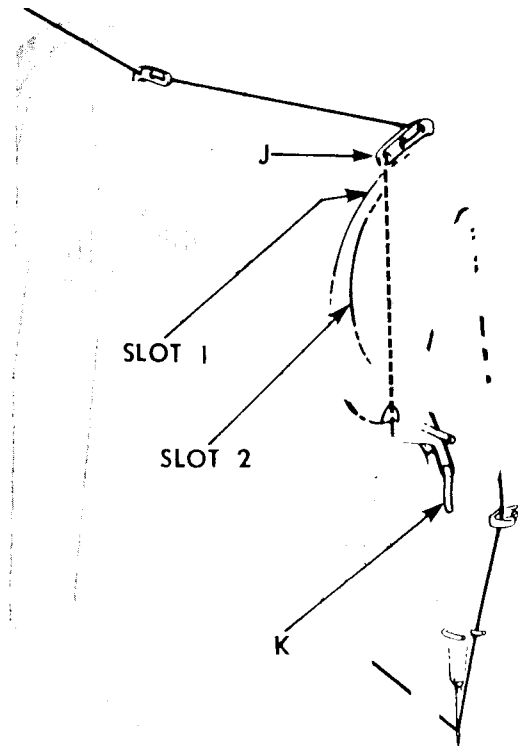

Fig. 11. Rear View of Machine, Showing Upper Threading

Pass the thread through the threading points in the manner shown in Fig. 11. Hold the thread with the right hand near the thread retainer **J** while passing the thread, with the left hand, downward into the inner slot **1** and on down around and between the tension discs, into the take-up spring and under the thread pull-off **K**, then over through the slot **2**, allowing the thread to fall in place over the take-up disc, as shown in Fig. 11, then release the thread with the right hand and continue to pass it down through the two thread guides and from left to right through the eye of the needle. Leave about three inches of thread with which to commence sewing.

TO PREPARE FOR SEWING

With the left hand hold the end of the needle thread, leaving it slack from the hand to the needle, turn the machine pulley over from you until the needle moves down and up again to its highest point, thus catching

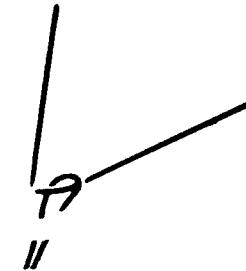

Fig. 12. Drawing Up the Bobbin Thread

the bobbin thread; draw up the needle thread and the bobbin thread will come up with it through the hole in the throat plate. See Fig. 12. Lay both threads back under the presser foot.

TO COMMENCE SEWING

Place the material beneath the presser foot, lower the presser foot and commence to sew.

TO REMOVE THE WORK

Stop the machine when the needle bar has just started to descend. In this position the upper thread will be free of the sewing hook and the take-up will not unthread the needle when the machine is started. Raise the presser foot, draw the work back and cut the threads close to the work.

TO REMOVE BROKEN THREAD FROM TAKE-UP

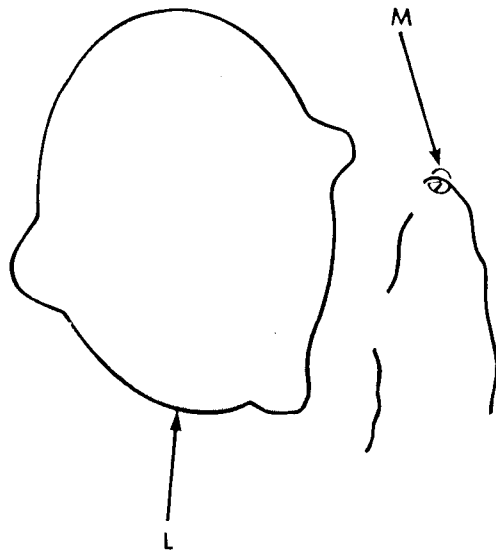

K472B

Fig. 13. To Remove Broken Thread from Rotary Take-up

If the thread breaks at operating speeds, an extra piece of thread may be found in the take-up which is visible through grille L. Open the grille and remove the thread, then close the grille and rethread.

CAUTION : When removing end of thread from the take-up, be careful not to cut fingers on the thread cutter M.

If no end of thread is visible around the take-up, just rethread and proceed to sew.

TENSIONS

For ordinary stitching, the needle and bobbin threads should be locked in the centre of the thickness of the material, thus :



Fig. 14. Perfect Stitch

If the tension on the needle thread is too tight, or if that on the bobbin thread is too loose, the needle thread will lie straight along the upper surface of the material, thus :



Fig. 15. Tight Needle Thread Tension

If the tension on the bobbin thread is too tight, or if that on the needle thread is too loose, the bobbin thread will lie straight along the under side of the material, thus :



Fig. 16. Loose Needle Thread Tension

TO REGULATE THE TENSIONS

THE TENSION ON THE NEEDLE THREAD SHOULD BE REGULATED ONLY WHEN THE PRESSER FOOT IS DOWN. Having lowered the presser foot, turn the small thumb nut at the front of the tension discs over to the right to increase the tension. To decrease the tension, turn this thumb nut over to the left.

The tension on the bobbin thread is regulated by the large screw H, Fig. 7 in the tension spring on the outside of the bobbin case. To increase the tension, turn this screw over to the right. To decrease the tension, turn this screw over to the left.

When the tension on the bobbin thread has been once properly adjusted, it is seldom necessary to change it, as a correct stitch can usually be obtained by varying the tension on the needle thread.

TO REGULATE THE PRESSURE ON THE MATERIAL

The pressure of the presser foot on the material is regulated by the screw **N**, Fig. 17 in the top of the arm. Turn this screw downward, **clockwise**, to increase the pressure or upward, **counter-clockwise**, to decrease the pressure. The pressure should be set only sufficiently strong to satisfactorily feed the work.

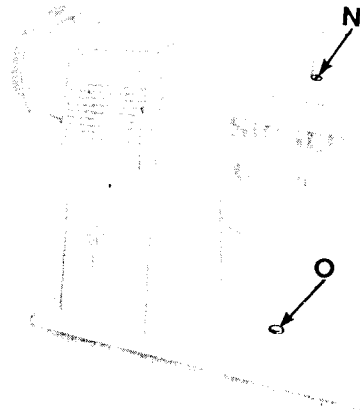

Fig. 17. Screw **N** for Regulating Pressure on Presser Foot and Stud **O** for Regulating Length of Stitch

TO REGULATE THE LENGTH OF STITCH

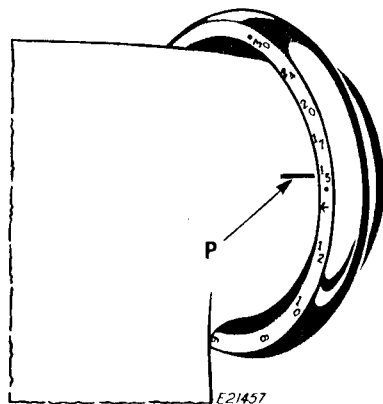

Fig. 18. Stitch Indicator

To change the length of stitch, press down the stud **O**, Fig. 17 in the bed of the machine and at the same time turn the driving pulley slowly over from you until the stud enters a notch in the adjustable feed eccentric cam on the bed shaft. Still holding the stud, turn the driving pulley until the number indicating the number of stitches per inch desired is opposite the mark **P**, Fig. 18, then release the stud. **DO NOT TOUCH THE STUD **O** WHILE THE MACHINE IS RUNNING.**

TO REVERSE THE DIRECTION OF FEED

To feed the goods **toward you**, push down the lever **U3**, Fig. 19 as far as it will go. Feeding in this direction continues only as long as lever is held in depressed position. Normal feeding is resumed upon release of lever **U3**, Fig. 19.

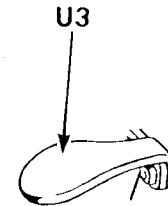

Fig. 19. Showing Lever for Reversing Direction of Feed

The direction of feed can be reversed at any point of a seam while the machine is in operation without removing the work. Back tacking is therefore readily accomplished and the ends of seams are easily fastened.

HINTS FOR PERFECT OPERATION

Follow instructions and oil machine regularly.

The driving pulley must always turn away from the operator.

Do not run machine with bobbin case only partly inserted.

Do not run the machine with the presser foot resting on the feed without cloth under the presser foot.

Do not run the machine when both bobbin case and needle are threaded unless there is material under the presser foot.

Do not try to help the machine by pulling the fabric lest you bend the needle. The machine feeds the work without assistance.

The slide over the bobbin case should be kept closed when the machine is in operation.

Do not press on the knee lifter lever while the machine is in operation, as this might prevent the work from feeding properly.

Occasionally remove the accumulation of lint from around the hook and from between the feed rows beneath the throat plate.

NEVER TOUCH THE STITCH REGULATOR STUD WHEN THE MACHINE IS RUNNING.

Never run machine with the take-up cover open.

TIMING THE MACHINE

The parts are in their proper timing on the various shafts when the locating screws are in the shaft splines provided for them. These locating screws are the first screws appearing when the shafts are revolved in their normal direction of rotation and are provided with a cone shaped point.

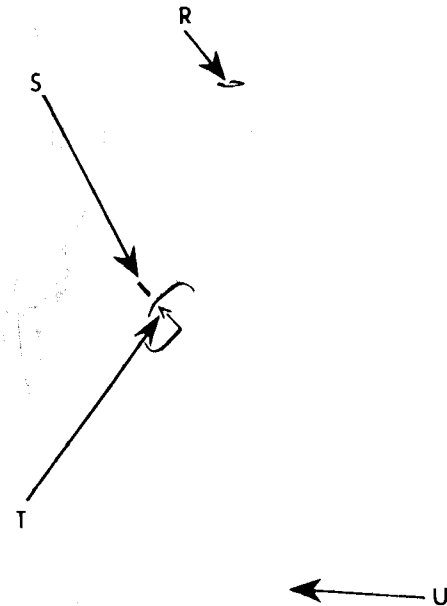

Fig. 20. Showing Timing Marks on Take-up and Take-up Clamping Plate

For normal sewing, the rotary thread take-up is correctly timed when the timing mark S, Fig. 20 on the take-up is in line with the arrow T, Fig. 20 on the clamping plate.

Some types of thread and materials, may require a slightly different timing of the take-up than that described above. To **advance** the take-up, loosen the two screws in the clamping plate T and move the take-up S **counterclockwise**. To **retard** the take-up, move it **clockwise**. After timing the take-up, securely tighten the two screws in the clamping plate T.

The needle bar and sewing hook are timed as described on page 20.

TO ADJUST THE THREAD TAKE-UP SPRING

The thread take-up spring X, Fig. 21 should have just enough movement so that it will be through acting and will rest against the upper end of the spring regulator V, Fig. 21 when the point of the needle reaches the throat plate on the downward stroke of the needle bar. After loosening the set screw Y, Fig. 21, the tension will turn with the stud W, Fig. 21 and the spring regulator may be turned to the required position, then tighten the set screw Y.

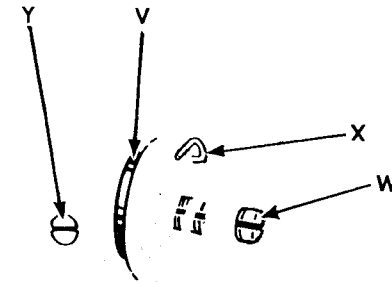

Fig. 21. Take-up Spring Adjustments

The tension on the thread take-up spring X is regulated by turning the tension stud W, Fig. 21 to the left to increase the tension, or to the right to decrease the tension. The tension on the thread take-up spring should be just sufficient to take up the slack of the needle thread until the point of the needle reaches the throat plate on the downward stroke of the needle bar.

PRESSER BAR ADJUSTMENTS

The presser bar bushing **A2**, Fig. 22 should be set so that its top is even with the top of the lifting bracket **B2**, Fig. 22 when the bracket is all the way down.

The presser bar position guide **C2**, Fig. 22 should be set about 1/16 inch above the top of the lifting bracket **B2** when the presser foot is down on the throat plate. This setting should leave 1/16 inch clearance between casting and presser bar position guide **C2**.

With the feed dog and presser foot down, there should be a slight free motion in the hand lifter lever so that the presser foot will rest on the work during operation of the machine.

To align the presser foot with the needle, have the presser foot down on the throat plate, loosen the screw **D2**, Fig. 22, turn the presser foot to the desired position and retighten the screw **D2**.

The spring **P3**, Fig. 36, between the bed casting and collar **O3**, Fig. 36, on the knee lifter lifting rod, cushions the action of the lifting bracket.

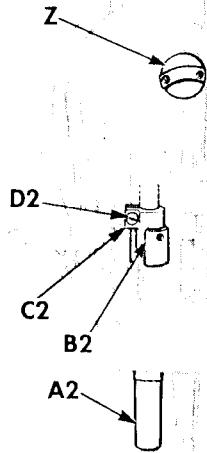

Fig. 22. Face Plate Removed

ADJUSTMENT OF THE TENSION RELEASER

The tension releaser **J2**, Fig. 23 automatically releases the spring pressure on the tension discs when the presser bar is raised. The releaser may be moved up or down to release the tension earlier or later, by loosening the screw **K2**, Fig. 23.

When stitching on heavy material, the releaser should be set lower than when on light work to prevent stitching with a released tension while sewing heavy material.

TO SET THE NEEDLE BAR AT THE CORRECT HEIGHT

When the needle bar is at its highest position, the lower timing mark **H2**, Fig. 23 on the needle bar should be just visible at the lower end of the needle bar bushing **F2**, Fig. 23. If the needle bar is not correctly set, loosen the screw **E2**, Fig. 23 in the needle bar connecting stud and move the needle bar to the correct position.

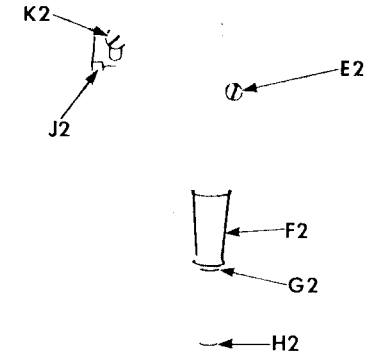

Fig. 23. Setting Needle Bar

TO SET NEEDLE BAR AT THE CORRECT HEIGHT IF NEEDLE BAR BUSHING SETTING HAS BEEN DISTURBED

Set the needle bar when at the bottom of its stroke so that the eye of the needle is above the needle guard of the bobbin case holder just enough to allow freedom for the thread, as shown in Fig. 26. Then with the needle at its highest position, the bushing can be reset by driving it so that the lower timing mark **H2**, Fig. 23 on the needle bar is just visible at the lower end of the bushing.

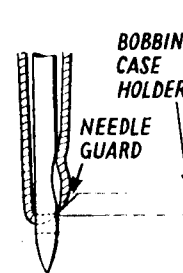

Fig. 24
Needle Too Low When
At Bottom of Stroke

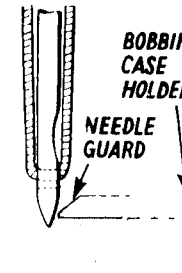

Fig. 25
Needle Too High When
At Bottom of Stroke

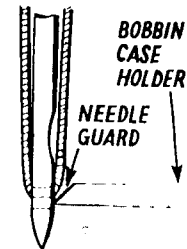

Fig. 26
Correct Height of
Needle When at
Bottom of Stroke

Turn top of machine pulley over from you until the needle has risen .100 inch (1/10 inch) from its lowest position. In this position, the hook timing mark **Θ**, Fig. 28 on the machine pulley will be in line with the mark **P**, Fig. 28 on the arm casting. Then set the hook so that its point is at the centre of the needle and positioned as described on page 20.

TIMING THE SEWING HOOK

First see that the needle bar is correctly set as instructed on page 19. Remove presser foot, slide plate, throat plate, bobbin case, feed dog and bobbin case holder position finger. Rotate the bobbin case holder about one-half turn so that it is clear of the needle.

To determine whether the hook is correctly timed, place a new needle in the machine, then turn the top of the machine pulley over from you until the needle bar has started to rise from its lowest position and the upper timing mark G2, Fig. 23, is just visible at the lower end of the needle bar bushing F2, Fig. 23. In this position, the hook timing mark Θ , Fig. 28 on

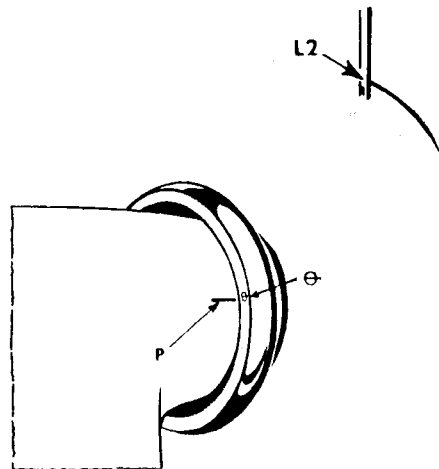

Fig. 28
Showing Timing Mark on
Machine Pulley

the machine pulley will be in line with the mark P, Fig. 28 on the arm casting and the point of the sewing hook should be at the centre of the needle, as shown at L2, Fig. 27.

If the hook time is incorrect, loosen the two screws M2, Fig. 33 in the hub of the hook and turn the hook on its shaft to bring into correct timing.

The point of the hook should pass the needle as closely as possible without actually touching it. This is equal to about the thickness of a piece of ordinary note paper. The hook should be placed on the shaft as far as it will go. If it is necessary to move the hook sidewise, loosen the set screw O2, Fig. 33, and move the bushing N2, Fig. 33, with the hook assembly as required, tapping it to the right or prying it to the left with a screwdriver against the bed casting.

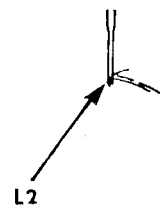

Fig. 27
Timing Sewing Hook

TO DETERMINE CORRECT RELATIONSHIP OF NEEDLE GUARD TO NEEDLE

The function of the needle guard Fig. 29 of the bobbin case holder is to prevent the hook point from coming into contact with the needle at loop-taking time in case the needle is deflected sidewise toward the hook point. (However, it will, at this time, cause little or no deflection of the needle, as shown in Fig. 29). When the needle guard is correctly related to the needle, it will deflect the needle slightly to the left as the needle approaches its lowest position.

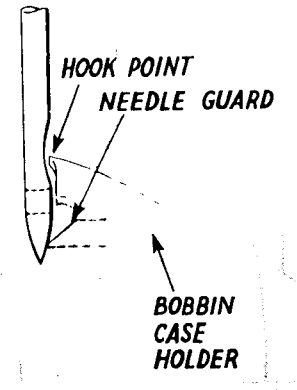

Fig. 29 Showing Correct
Relationship of Needle Guard
and Sewing Hook Point to
Needle at Loop-taking Time

It will sometimes be necessary to string the needle guard, as shown in Fig. 31, to provide additional clearance for the needle. Before doing this, the machine should be properly adjusted as previously described. Check the settings in the following order:

1. See that needle bar is set at correct height. See page 19.
2. Make sure that sewing hook is accurately timed. See page 20.
3. See that clearance between sewing hook point and needle is correct. See page 20.
4. Rotate bobbin case holder to its normal position and replace position finger.

5. Check position of bobbin case holder position finger Fig. 30. The clearance between position finger and bobbin case holder should be just sufficient to allow thickness of thread to pass through easily. Normal setting is for approximately .020 inch clearance, as shown in Fig. 30. The finger should also be level with the top of bobbin case holder.

When it is necessary to provide more clearance for needle, remove bobbin case holder from hook and remove a slight amount of metal from needle guard, by using a 1/8 inch strip of very fine emery cloth (about No. 320), holding one end of the emery cloth in a vice and rubbing the edge of the needle guard along the strip, as shown in Fig. 31. Extreme care must be taken not to remove too much metal as this will allow the hook point

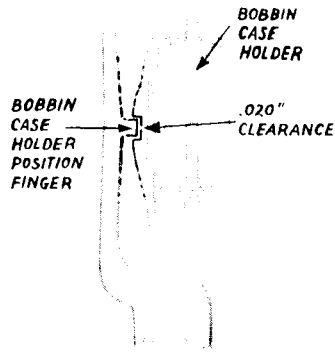

Fig. 30. Showing Thread Clearance Between Bobbin Case Holder Position Finger and Bobbin Case Holder



Fig. 31. Stringing Needle Guard of Bobbin Case Holder

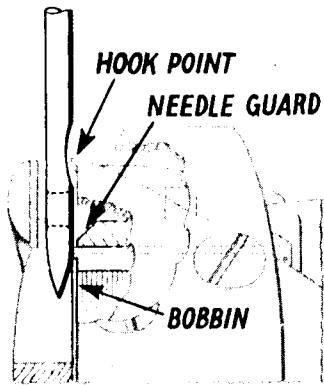

Fig. 32. Showing Needle Striking Bobbin Due to Removal of Too Much Metal from Needle Guard

to rub the needle, causing wear or damage and thus necessitate replacing the hook and the bobbin case holder. Removing too much metal from guard can expose bobbin, permitting needle to strike it as shown in Fig. 32, and become damaged or broken and to also damage bobbin. Be sure to clean bobbin case holder thoroughly before replacing it.

TO REMOVE AND REPLACE THE SEWING HOOK

Remove the needle, slide plate and bobbin case. Take out the screw Q2, Fig. 33 and remove the bobbin case holder position bracket P2. Loosen the two set screws at M2 in the hub of the hook, then turn the machine pulley over from you until the feed bar R2, Fig. 34 is raised to its highest point. Turn the sewing hook until the thread guard T2 is at the bottom, as shown in Fig. 34, and turn the bobbin case holder U2 until it is in the position shown in Fig. 34. The sewing hook can then be removed from the hook shaft.

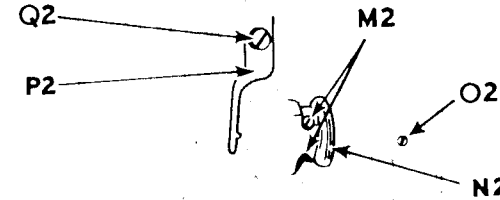

Fig. 33. Removing Hook

When placing a new sewing hook on the shaft, have the thread guard T2 of the hook at the bottom and the bobbin case holder U2 turned to the position shown in Fig. 34, so that the hook will clear the feed bar R2. Press the hook on the shaft up tightly against the shoulder.

When the hook is in position on the shaft, replace needle and retune as instructed on page 20. Turn the bobbin case holder U2 until the notch S2 is at the top, then replace the bobbin case holder position bracket, being careful to see that the position finger enters the notch at the top of the bobbin case holder, as shown in Fig. 30, then securely fasten the position bracket by means of the screw Q2, Fig. 33. Replace the bobbin case and slide plate.

TO REMOVE AND REPLACE THE HOOK DRIVING SHAFT

Slip the belt off the lower pulley **F3**, Fig. 36, then loosen the two set screws **G3**, Fig. 36 and remove the pulley from the shaft. Loosen the four set screws **B3** and **E3**, Fig. 36 in the feed and feed lifting eccentrics, and the two set screws at **N3**, Fig. 36 in the internal gear. Do not loosen the screw in the collar **J3**, Fig. 36. Withdraw the shaft with ball bearing from the pulley end.

When replacing the shaft, make sure oil lead wire is in place in the shaft, and push shaft in, being sure the feed eccentrics are on the shaft in their proper order, until the snap ring on the ball bearing seats on the casting, then tighten gear screws **N3**. Before tightening the screws **B3**, the feed eccentric should be pushed to the left as far as it will go.

Tighten the screws **B3**, Fig. 36, having the first screw (as the shaft is turned away from you) enter the groove in the shaft. Then move the feed lifting eccentric to the left as far as it will go and tighten the screws **E3**, with the first or upper set screw in the groove in the shaft. Replace pulley **F3** and belt. Then retime the shaft as instructed on page 16.

If it is found necessary to replace the ball bearing on the hook driving shaft, or to reset or replace the hook driving shaft bushing, note that the ball bearing is correctly positioned when the pulley **F3**, Fig. 36 is flush with the ball bearing on one side and its hub is flush with the end of the shaft on the other. With the ball bearing in this position, place the shaft in the machine

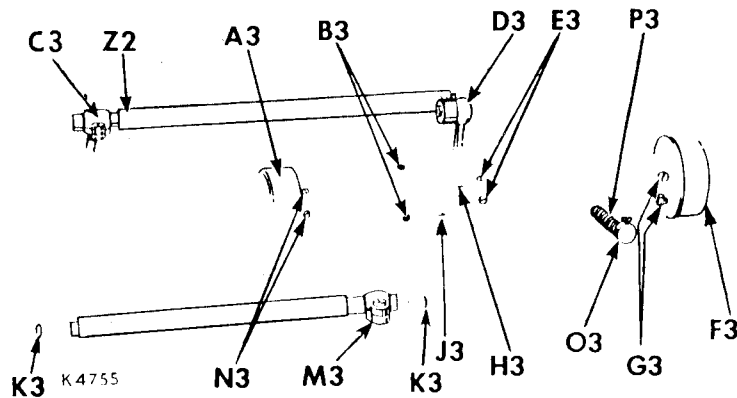

Fig. 36. Underside of Machine

and assemble the internal gear **A3**, Fig. 36 with its inner face flush with the end of the shaft. The hook driving shaft bushing will be correctly positioned when end play has been removed from the shaft by setting the bushing against the hub of the internal gear.

If the feed rock shafts have been disturbed, the small end of the connection **D3**, Fig. 36 and the forked end of the feed driving eccentric connection should be disconnected while setting the eccentrics and enough side play left for the connections so that their free ends can be moved sidewise about 1/32 to 1/16 inch. See paragraph on feed mechanism before assembling the rock shaft connections.

The bearings for the feed rock shafts are fitted with Nylon inserts. These inserts may be removed when worn by inserting a screw in the threaded hole provided for this purpose in the insert.

FEED MECHANISM

If a faster or slower feed timing than the standard setting is desired see page 26, loosen the pulley screws **G3**, Fig. 36 and turn the shaft as desired, then tighten the screws. The hook must then be retimed as instructed on page 20.

The feed dog is lined up with the slots in the throat plate by moving the bearing centres at **K3**, Fig. 36 to the right or left, at the same time loosening the clamp screw on the feed lifting rock shaft crank **C3**, Fig. 36 allowing it to line up with the feed bar linkage. The feed dog may be centred lengthwise so that it will not strike the ends of the slots when making the longest stitch, by loosening the clamp screw in the feed rock shaft crank **M3**, Fig. 36.

After removing the feed driving or feed lifting rock shafts, the crank **M3**, Fig. 36 through its linkage, and the rock shaft **Z2**, Fig. 36 with its crank portion, should be adjusted to the right or left until they line up perfectly with the free ends of the connections when the latter are exactly midway between their two extreme side play positions. Before adjusting the rock shaft **Z2**, Fig. 36 to right or left it will be necessary to loosen the clamping screw in the feed lifting crank **C3**, Fig. 36. The cone bearing **D3**, Fig. 36 should then be adjusted by first turning the cone screw down tight and then backing it off about one-eighth of a turn, locking it in position with the lock nut. This gives a minute amount of play in the connection which is necessary for all clearance.

SETTING THE FEED DOG AT THE CORRECT HEIGHT

The feed dog may be raised or lowered by loosening the pinch screw in the feed lifting crank **C3**, Fig. 36. The feed dog is usually set so that it shows a full tooth above the throat plate when at its highest position. See that there is no lint packed between the feed dog and the throat plate.

ADJUSTING FEED ECCENTRIC

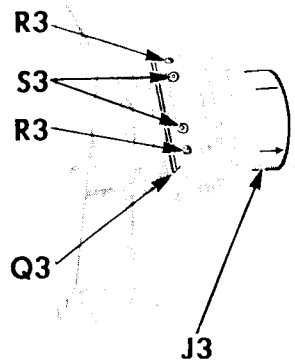

Fig. 37. Feed Eccentric

the eccentric will be locked so that the stitch length cannot be changed by unauthorised persons.

A spring held by the collar **J3** presses against the feed eccentric cam to prevent it from moving out of position while the machine is operating. The collar **J3** should ordinarily be set flush with the end of the hub of the eccentric body. The set screw in this collar must enter the timing groove in the eccentric body.

TO ADJUST FEED DRIVING AND REVERSING MECHANISM

The position in which the feed reversing lever crank **W3**, Fig. 38 is secured to the feed reversing shaft affects the actual travel of the feed dog with respect to the setting of the feed driving eccentric. The proper position can best be obtained by actual trial. To do this, set the feed driving eccentric to its longest stitch by depressing the button in the bed and rotating the machine

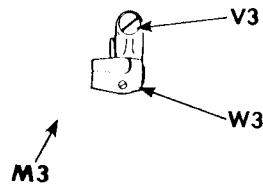

Fig. 38. Adjustment of Reverse Feed Mechanism

The feed eccentric is provided with a gib **Q3**, Fig. 37 which can be adjusted to take up any loose motion between the feed eccentric and the eccentric body. To adjust the gib, loosen the two locking screws **R3** nearest the gib, then turn in the two adjusting screws **S3** against the gib until all play is eliminated and the eccentric fits snugly in the slot in the eccentric body. Securely tighten the two locking screws **R3**. By tightening the adjusting screws **S3** firmly,

pulley until the numeral 6 is in line with the mark on the arm adjacent to the pulley. Then with the feed reversing lever handle in normal position (the feed reversing lever should be against the top of its slot in the arm casting), set the feed reversing lever crank **W3**, Fig. 38 so that the feed dog produces six needle punctures to the inch on paper. This can be accomplished by loosening the pinch screw **V3**, Fig. 38 and rotating this crank on the shaft to various positions until 6 stitches per inch are obtained.

The machine is now correctly set for its maximum stitch of six to the inch and when reversed will produce a slightly shorter stitch. This condition is correspondingly true on all lengths of stitch.

When the feed reversing lever handle is in the reverse position, the feed reversing shaft crank hinge stud will stop against the angle cut on the side of the oil reservoir on the bed. The feed reversing lever will be approximately $5/32$ " short of bottoming against the end of its slot in the arm casting.

TO REMOVE AND REPLACE THE ARM SHAFT CONNECTION BELT

Remove the needle to avoid damaging it while the arm and hook shafts are out of time. Work the belt off the lower pulley **F3**, Fig. 36.

Loosen the two screws in the pulley groove and remove the machine pulley and the ball bearing which comes out with the pulley. Lift the belt up and draw it out around the arm shaft through the space normally occupied by the ball bearing.

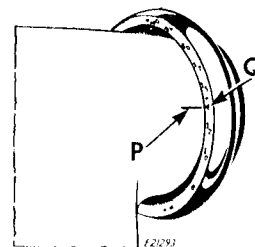

Fig. 39
Showing Timing Arrow
on Machine Pulley

Replace the belt through the ball bearing hole. After placing the belt over the upper pulley **T3**, Fig. 40, replace the machine pulley. To remove all end play from the shaft, lightly tighten the set screws in the machine pulley and, holding the needle bar crank in place, tap the machine pulley into position with the palm of the hand; then tighten screws firmly. Turn the arm shaft until the arrow **Q**, Fig. 39 on the machine pulley is in line with the mark **P**, Fig. 39 on the arm casting, then turn the lower shaft pulley until the timing mark on the collar **J3**, Fig. 36 is opposite the timing mark **H3**, Fig. 36, being careful to see that the two set screws **G3**, Fig. 36 are accessible. With the two shafts in this position, lead the belt onto the lower pulley at the point farthest from you and then, while turning the machine pulley over from you, slide the belt over the rest of the width of the lower pulley. Check the timing of the machine before starting to sew; see page 16, and if necessary, loosen the set screws in the lower pulley to bring the upper and lower shafts into exact time.

TO REMOVE THE ARM SHAFT

The arm shaft must be removed from the face plate end of the machine and under no circumstances should an attempt be made to separate the needle bar crank from the shaft, as they are manufactured as a unit for accuracy. Remove face plate **U**, **Fig. 20** and associated parts. Remove the needle set screw. Loosen the needle bar pinch screw **E2**, **Fig. 23**, remove the needle bar through the top of the arm, and remove the needle bar connecting stud. Remove the needle bar crank stud **Z**, **Fig. 22** by loosening the two set screws, reached through hole **R**, **Fig. 20** in the top of the arm. To remove the needle bar connecting link, drop it to its lowest position,

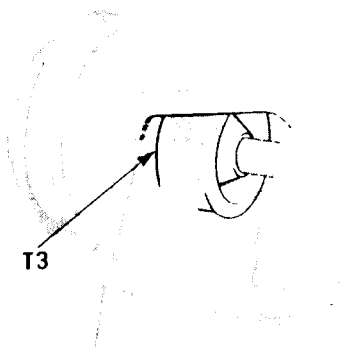

Fig. 40. Showing Upper Pulley

draw forward out of the guide block, turn at right angles, then draw upward and outward. (If for any reason the needle bar guide block is disturbed, it must be aligned properly when assembling the machine). Remove the belt as instructed on the preceding page, loosen the spot screw and set screw in pulley **T3**, **Fig. 40** and withdraw the arm shaft and crank from the needle bar end. If it is found necessary to replace the ball bearing, it should be forced onto the shaft until it rests against the oiling felt flange, being careful not to crush the flange.

INSTRUCTIONS ON BALL BEARINGS AND NEEDLE BEARINGS

There are three ball bearings and three needle bearings in these machines that will give long, trouble-free life with reasonable care. Oiling instructions given on pages 4 and 5 should be followed carefully. Care should be taken to see that no foreign matter gets into these bearings when handling them out of the machine.

The ball bearings on the forward end of the arm shaft, and the rear end of the hook driving shaft are forced on into their correct position at the factory and should not be removed except for replacement. When replacing them, make certain that the shielded side is always out and that they are a tight fit on their respective shafts.

The ball bearing on the machine pulley is also a forced fit.

The three needle bearings should receive the same care as the ball bearings and should not be removed from their respective housings except for replacement. They should be replaced by pressing on the numbered end of the outside shell as any pressure on the unnumbered end of the shell will distort them and cramp the bearings. After this, care should be taken to see that the needle bearings roll freely in their respective housings.